

REVISION BLOCK			
REV	DESCRIPTION	DATE	INCORP. BY

University of Hawaii Institute for Astronomy			
DWG #	REV	TITLE	
T3-2300	-	Lab System Overview	
ENGINEER E. Warmbier	LAST EDIT 7/20/2009 5:12:41 PM	SIZE B	SHEET 1 of 1
FILE: Y:\public_html\tcs3\Design\T3-2300_Lab_System_Overview.vsd			

REFERENCE DWG T3-2301

REF DWG T3-2312

REF DWG T3-2302

REF DWG T3-2311

REF DWG T3-2310

(all OEM - see manufacturer DWGs)

Motors are Maxon DC Motors
Part # 2260.889-51.216-200

Mechanical Structure

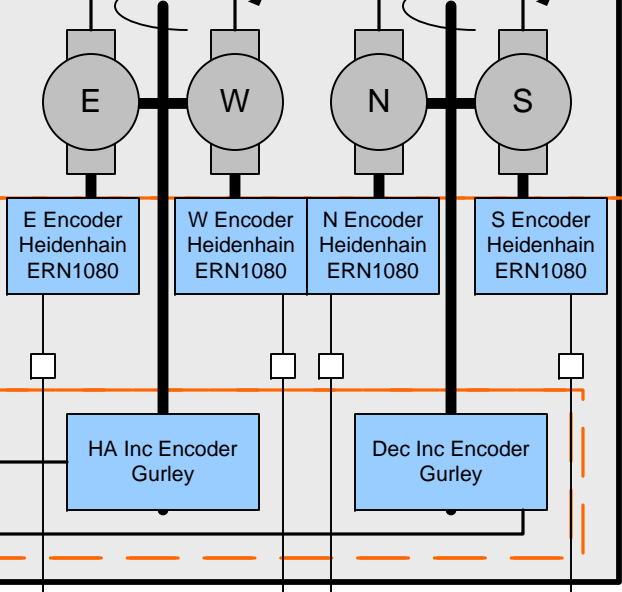

REF DWG T3-2301

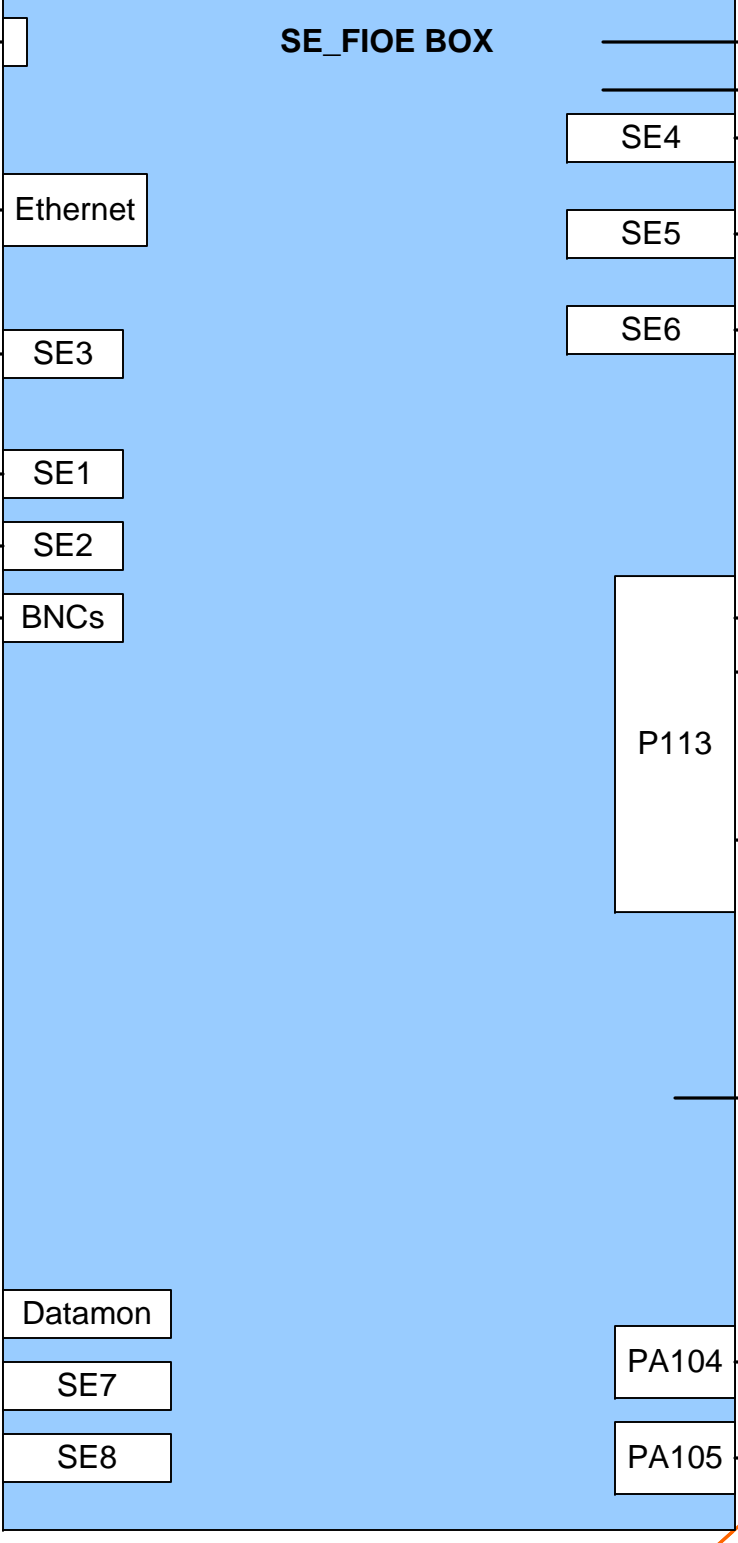
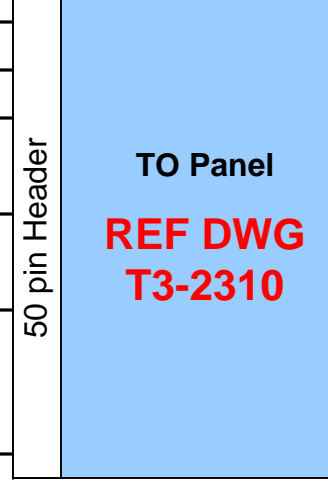
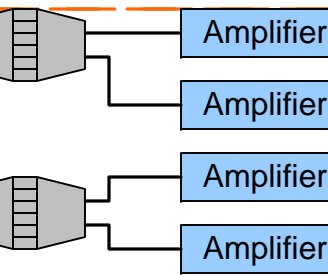
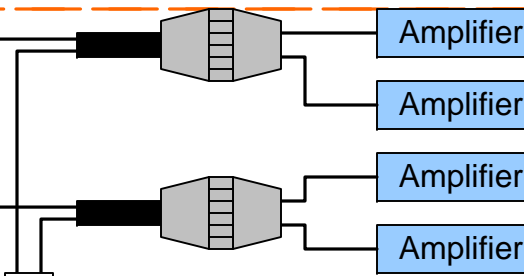
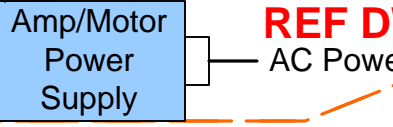
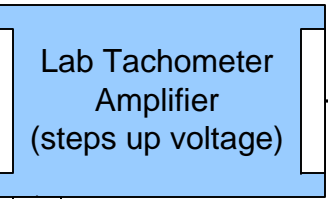
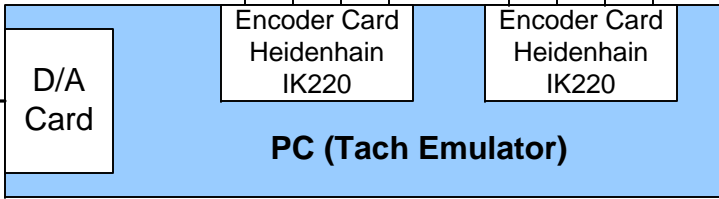

(not installed)
Datamon
(not installed)
SE7
(not installed)
SE8

4 (E.W.N.S)

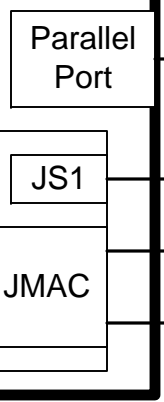
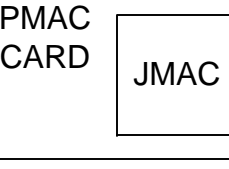

AC Power

AC Power

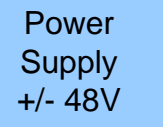

University of Hawaii
Institute for Astronomy

University of Hawaii Institute for Astronomy			
DWG #	REV	TITLE	
T3-2300	-	Lab System Overview	
ENGINEER E. Warmbier	LAST EDIT 7/20/2009 5:12:41 PM	SIZE B	SHEET 1 of 1
FILE: Y:\public_html\tcs3\Design\T3-2300_Lab_System_Overview.vsd			