



Digi One[®] and PortServer[®] TS Family

Digi One Family Products

PortServer TS Family Products

PortServer TS Family (RS-232 only) Products:

PortServer TS 1/2/4 Family Products

PortServer TS 8/16 Family Products

PortServer TS MEI Products

Digi Remote Power Manager (Digi RPM)

© 2008 Digi International Inc.

Digi, Digi International, the Digi logo, Digi One, Digi Connect, PortServer TS, and RealPort are trademarks or registered trademarks of Digi International, Inc. in the United States and other countries worldwide. All other trademarks are the property of their respective owners.

About This Guide	9
Purpose	9
Audience.....	9
Scope	9
Other Documents in the Library.....	9
Quick Start Guide	9
Command Reference	9
Online Help for the Web UI (User Interface)*	9
Digi Contact Information	10
Chapter 1 Configure the IP Address	11
Options for Configuring the IP Address and Mask	11
Configure the IP Address Using ARP-Ping	11
Configure an IP Address using DHCP and RARP	12
About DHCP and RARP	12
DHCP option 12.....	12
DHCP option 81 FQDN (Fully Qualified Domain Name)	12
Procedure	12
Access the Digi Device.....	13
Chapter 2 Introduction	15
Devices in the Digi One and PortServer TS Family.....	15
Digi One Family	15
PortServer TS Family	15
Setup Overview	17
Step 1: Plan	17
Step 2: Set Up the Hardware.....	17
Step 3: Configure an IP Address	17
Step 4: Configure Ports	17
Step 5: Configure Other Features as Required	17
About Configuration Methods	18
Configure the Digi Device from an Attached Terminal.....	18
Configure the Digi Device from a Telnet Session	18
Configure the Digi Device from the Web Interface	18
Downloading a Configuration File.....	18
Accessing the Configuration from the Web Interface	19
Quick Reference for Configuring Features	19
Chapter 3 Configure Network and Serial Ports	25
Assumptions	25
Network Settings	25
Advanced Network Settings	27
Configure Serial Ports	28
Port Profiles	30

RealPort Port Profile	30
Console Management Port Profile.....	31
TCP Sockets Port Profile	32
UDP Sockets Port Profile	33
Serial Bridging Port Profile	34
Printer Port Profile	34
Using the LPD Protocol	35
Examples	35
Terminal Port Profile.....	36
Industrial Automation Port Profile	37
Configure Industrial Automation with Modbus	38
Chat Mode Port Profile	39
Modem Port Profiles	40
Modem Emulation Port Profile	40
Modem Port Profile	41
Internal Modem Port Profile	42
Power Management Port Profile.....	43
Custom Port Profile	44
User Configuration.....	45
Common User Features	45
Add a User.....	46
Configure User Access Method.....	46
Change or Update User Passwords	46
Security Configuration	47
Enabling and Disabling Access to Network Services	47
Configure Security Settings	48
System Configuration	48
PPP Settings	49
Configure SNMP Settings.....	51
Configure MEI Settings.....	52
Autoconnection.....	53
Configure a Port for Autoconnection	53
Configure a User for Autoconnection	53
Chapter 4 Configure Industrial Automation (IA)	55
Key Terms in This Chapter.....	55
Industrial Automation Configuration Wizard	56
Industrial Automation Configuration Profiles	56
Industrial Automation Configuration Procedures.....	56
Serial Bridge Profile: Master and Slave Connected to Digi Ports.....	57
When to Use	57
Configuration Options.....	57
Setup Information: Slave Side	57
Setup Information: Master Side	57
Modbus Profile: Serial-Connected Slave.....	58
When to Use	58
Configuration Options.....	58
Setup Information	58
Modbus Profile: Serial-Connected Master.....	59

When to Use	59
Configuration Options	59
Setup Information	59
DF1 Profile: Serial-Connected Slave	60
When to Use	60
Configuration Options	60
Setup Information	60
DF1 Profile: Serial-Connected Master	61
When to Use	61
Configuration Options	61
Setup Information	61
Omron Family Profile: Serial-Connected Slave	62
When to Use	62
Configuration Options	62
Setup Information	62
Omron Family Profile: Serial-Connected Master	63
When to Use	63
Configuration Options	63
Setup Information	63
Other Serial Port Protocol Profile: Serial-Connected Slave	64
When to Use	64
Configuration Options	64
Setup Information	64
Other Serial Port Protocol Profile: Serial-Connected Master	65
When to Use	65
Configuration Options	65
Setup Information	65
Configure a Serial-Connected Slave: Generic Procedure	66
When to Use	66
Procedure	66
Configure a Serial-Connected Master: Generic Procedure	66
When to Use	66
Procedure	66
Configure a Serial-Connected Master: TCP/UDP Sockets	67
When to Use	67
Procedure	67
Configure a Serial-Connected Slave: Other IA Protocol	67
When to Use	67
Procedure	67
Configure a Serial-Connected Master: Other IA Protocol	68
When to Use	68
Procedure	68
Set Up COM Port Redirection	69
When to Use	69
Setup Tasks: An Overview	69
Procedure: Configure the Serial Port for RealPort	70
Update POST Code	70
Prerequisite	70
Procedure	70

RealPort: Determining whether to Install RealPort	71
Chapter 5 Configure Wireless Devices	73
Configuration Considerations	73
Initial Configuration Using Ethernet	74
Chapter 6 Configure MEI Settings	77
About MEI Settings	77
Configure the MEI Switches	77
Set the Supported Baud Rate for Multi-drop Support	78
Four-Wire Multi-Drop Network Scenarios	78
MEI Configuration for a Single Master:	78
MEI Configuration for a Slave:	78
Table for Pin Outs	79
Chapter 7 Configure Embedded Modem	81
Embedded Modem	81
Install the PortServer TS 1/3 M MEI	81
Configure the PortServer TS 1/3 M MEI	82
Chapter 8 Configure Power Over Serial Ports	83
Serial Power Feature	83
Configure RI Power	84
RI Power In	84
RI Power Out	84
Configure DTR Power	85
Power Out	85
Serial Power Table	86
Chapter 9 Digi Remote Power Manager (Digi RPM)	87
Configuration Scenarios Using Digi RPM	88
Non-Serial Device Connected to Digi RPM	88
Serial Device Managed by a PortServer TS, but Powered by Digi RPM	89
Digi RPM Configurable from Web User Interface or Command Line	89
Process for Configuring and Managing Digi RPM	90
Connect the Digi RPM to the PortServer TS Device and Power Up ...	90
Configure Digi RPM Settings	90
Configure Outlets	93
Manage Power Devices and Power Controllers	95
Manage Power Devices	95
Manage Power Controllers	96
Chapter 10 Configure SNMP	99
About SNMP and the Digi Device Agent	99
Network Management Components	99
SNMP Management Agent	99
SNMP Traps	100
MIB Support	100

Message Support	100
Supported Traps	100
Configuration Procedure: Web Interface	100
Chapter 11 Configuration Management.....	101
Upgrade Firmware.....	101
TFTP Upgrade Procedure	101
Backup/Restore Device Configuration Settings.....	102
Backup Device Configuration Settings to a File	102
Restore Device Configuration Settings from a File.....	102
Backup/Restore to and from a TFTP Server	102
Reset Configuration to Factory Defaults.....	103
Reset Button Locations	103
Chapter 12 Latency Tuning.....	105
What is Latency?	105
Recommended Process for Latency Tuning	105
Best-case scenario	105
Step 1: Determine the characteristics of your application.....	106
Step 2: Determine latency budget and type of latency	106
Step 3: Optimize the physical layer	106
Step 4: Optimize the network and transport layers.....	107
Step 5: Optimize the application layer	108
Chapter 13 Reference and Certifications.....	109
Interpreting the LEDs.....	109
LEDs for PortServer TS 1/2/4-Port and Digi One Family Products	109
LEDs for PortServer TS 8/16 Products.....	110
Device EIA 232/422/485 Switch Settings	110
RJ-45 Pinouts	111
Safety Statements	112
PortServer TS 8/16.....	112
Rack Mounting Installation (PortServer TS 16 Rack and DC Rack).....	112
PortServer TS 1/3 M MEI	113
Class I Division 2, Groups A,B,C,D Hazardous Location	114
Specifications	115
Power Requirements	115
Physical Requirements.....	117
Digi One IA DB9 and Screw Terminal Pinouts	118
PortServer TS 1 M MEI and PortServer TS 3 M MEI	118
FCC Class A Statement	118
Regulatory Notices	119
Certifications.....	120
FCC Part 15 Class A	120
Radio Frequency Interference (RFI) (FCC 15.105)	120
Labeling Requirements (FCC 15.19).....	120
Modifications (FCC 15.21).....	120
Cables (FCC 15.27).....	121
ICES 003 Class B.....	121

Antennae (Wireless only)	121
Maximum Permissible Exposure (Wireless only).....	121
Declaration of Conformity	122

About This Guide

Purpose

This user guide provides the following:

- Configuration and administration procedures
- Configuration examples

Audience

This guide is intended for the person responsible for configuring and administering the Digi device. It assumes that this person has experience configuring network devices and is familiar with networking concepts.

Scope

This guide provides step-by-step instructions for configuring and administering your Digi device's main features. It focuses on performing these tasks through the Web user interface. It does not address how to configure every option, provide complete information on commands, or discuss hardware installation. These topics are covered in other documents in the Digi library.

Other Documents in the Library

The Digi library is a collection of documents found on the Software and Documentation CD under Documentation. The following is a description of the documents available on the CD.

Quick Start Guide

The guide that comes in the package with the Digi device covering the first steps necessary to get your device up and running. UNIX mounting instructions can be found on the Quick Start Guide.

Command Reference

This online manual, available on the Software and Documentation CD, provides complete information on commands.

Online Help for the Web UI (User Interface)*

This context-sensitive online help provides information on configuration fields used with web browser configuration interface.

*This information is part of the user interface and not an actual document on the CD.

Digi Contact Information

To contact Digi International for more information about your Digi products, or for customer service and technical support, use the following contact information:

To Contact Digi International by:	Use:
Mail	Digi International 11001 Bren Road East Minnetonka, MN 55343 U.S.A.
World Wide Web:	http://www.digi.com/support/
email	http://www.digi.com/support/
Telephone (U.S.)	(952) 912-3444 or (877) 912-3444
Telephone (other locations)	+1 (952) 912-3444 or (877) 912-3444

The next step in configuring your Digi product is to configure an IP address and access the device for more advanced configurations. You must set the initial IP before you can use the web interface. Once the IP is set, the device can be accessed through the web interface and any changes made including changing the IP address.

Important: Before you configure your device server, write down the MAC Address located on the bottom of your product. For Digi One IA and Digi One SP products, the MAC address also serves as the serial number.

Options for Configuring the IP Address and Mask

The device server IP address can be configured using the following methods:

- From the command line, using the “set config” command. See the *Digi One and PortServer TS Family Command Reference* for more details including syntax and supported devices.
- By updating the ARP table on a server and then pinging the Digi device (called ARP-Ping, see "Configure the IP Address Using ARP-Ping" on page 11).
- Using a DHCP server (see "Configure an IP Address using DHCP and RARP" on page 12.)
- Using a RARP server (see "Configure an IP Address using DHCP and RARP" on page 12.)

The IP address and mask can also be changed using the web interface, but not for initial IP address configuration.

Configure the IP Address Using ARP-Ping

An IP address can be configured by manually updating a server’s ARP table and then pinging the Digi device.

The ARP-Ping command assigns the IP address you designate but also assigns default subnet mask and gateway addresses. It is necessary to change the subnet mask and gateway addresses.

This procedure assumes that your Digi device is connected to the Ethernet network.

1. Record the MAC address of the Digi device. The MAC address is on the label side (bottom) of the unit.
2. Access a server on the same subnet as the Digi device.
3. Manually update the server’s ARP table using the Digi device’s MAC address and the IP address you want assigned to the Digi device. The following is an example of how this is done on a Windows NT 4.0 system:

```
arp -s 191.168.2.2 00-00-9d-22-23-60
```

Configure an IP Address using DHCP and RARP

4. Ping the Digi device using the IP address just assigned. For example:

```
ping 191.168.2.2
```

The ping will probably time out before there is a response from the Digi device.

5. Wait 30 seconds and then ping the Digi device again.

The Digi device replies to the ping, indicating that the IP address has been configured.

Configure an IP Address using DHCP and RARP

About DHCP and RARP

When the device server boots, it transmits a DHCP request and a RARP request. This continues until an address is assigned.

DHCP option 12

If the device is configured to use DHCP, the combined host and domain will be sent as a hint to the DHCP server when requesting an IP address. As a convention, some DHCP servers use this hint to assign the IP address associated with the host name.

DHCP option 81 FQDN (Fully Qualified Domain Name)

If the device is configured to use DHCP, and the FQDN option is enabled in the advanced settings menu, the device will send the combined host and domain name as a request to the DHCP server to assign the IP address associated with the host name.

Procedure

To use RARP or DHCP, follow these steps:

1. Set up an entry for an address on a DHCP or RARP server. If you intend to use RealPort, do the following:
 - Reserve a permanent IP address.
 - Record the IP address. You will need it when you configure the RealPort driver.
2. Power on the device server.

The DHCP or RARP server assigns the device server an IP address.

Access the Digi Device

1. Enter the IP address in the URL bar of your browser.
2. Enter your login name (`root`) and password (`dbps`).

The Home page for the Digi device appears allowing you to configure the device for your specific needs. A tutorial is available to guide you in your decisions. The **Help** button in the upper right corner is also available.



From the web interface, you make any changes you need for your configuration. Remember to click **Apply** to save your changes, and **Reboot** when you are ready for the changes to take effect.

Devices in the Digi One and PortServer TS Family

This manual uses “the Digi One and PortServer TS Family” to refer to all devices in the family, and family names to refer to a group of devices. For example, the command summaries in this chapter and the device-support information for each command description. Devices and family names included in the Digi One and PortServer TS Family are:

Digi One Family

The Digi One Family of devices includes:

- Digi One SP
- Digi One SP IA
- Digi One IA
- Digi One IAP
- Digi One IAP Haz

PortServer TS Family

The term “PortServer TS Family” refers to all PortServer TS devices. Within this family are two major groups of devices with different firmware:

- PortServer TS Family (RS-232 only) devices
- PortServer TS MEI devices

PortServer TS Family (RS-232 only) Devices

The term “PortServer TS Family (RS-232 only) devices” refers to these device families:

PortServer TS Family

- PortServer TS 1, formerly known as Digi One RealPort
- PortServer TS 2
- PortServer TS 4

PortServer TS 8/16 Family:

- PortServer TS 8
- PortServer TS 8 DC
- PortServer TS 16
- PortServer TS 16 Rack
- PortServer TS 16 Rack DC
- PortServer TS 16 Enterprise

PortServer TS MEI devices

The term “PortServer TS MEI devices” refers to these device families:

PortServer TS MEI Family

- PortServer TS 1 MEI, formerly known as Digi One TS
- PortServer TS 2 MEI
- PortServer TS 4 MEI

PortServer TS H MEI Hardened Family

- PortServer TS 1 H MEI
- PortServer TS 2 H MEI
- PortServer TS 4 H MEI
- PortServer TS 1 H^{CC} MEI
- PortServer TS 2 H^{CC} MEI
- PortServer TS 4 H^{CC} MEI
- PortServer TS 1 Haz MEI
- PortServer TS 2 Haz MEI
- PortServer TS 4 Haz MEI

PortServer TS M MEI Modem Family

- PortServer TS 1 M MEI
- PortServer TS 3 M MEI

PortServer TS P MEI Power Family

- PortServer TS 1 P MEI
- PortServer TS 2 P MEI
- PortServer TS 4 P MEI

PortServer TS W MEI Wireless Family

- PortServer TS 1 W MEI
- PortServer TS 2 W MEI
- PortServer TS 4 W MEI

PortServer TS 8/16 MEI Family

- PortServer TS 8 MEI
- PortServer TS 16 MEI

Setup Overview

The following is an overview of the process for setting up your Digi device. The rest of this guide provides details on each step of the process.

Step 1: Plan

Before beginning setup, consider the following:

- How to assign an IP address to the Digi device's Ethernet interface, which can be accomplished in a number of ways. See "Configure the IP Address" on page 11.
- The various ways in which your Digi device can be configured. See "About Configuration Methods" on page 18 for more information.

A key consideration is whether to use RealPort. Other considerations include the type of peripheral that will connect to the port and the peripheral's cabling requirements. See "RealPort: Determining whether to Install RealPort" on page 71 and the online RealPort driver documentation and Cable Guide, both of which are on the Software and Documentation CD.

Step 2: Set Up the Hardware

1. Mount brackets to side of device for rack mounting.
2. Adhere the rubber feet to the bottom of the device for desktop.
3. Connect the device to the network.
4. Connect peripherals to serial ports. See the *Cable Guide* on the Software and Documentation CD.
5. Connect the device to the network.
6. Connect the power supply to the Digi device.

Step 3: Configure an IP Address

There are a number of ways to configure an IP address. See "Configure the IP Address" on page 11 for more information.

Step 4: Configure Ports

See the following for more information:

- "Configure Industrial Automation (IA)" on page 55
- "Network Settings" on page 25

Step 5: Configure Other Features as Required

See the following for information on setting up other features:

- "Security Configuration" on page 47
- "PPP Settings" on page 49
- "Autoconnection" on page 53

About Configuration Methods

Use this section to learn about the different methods for configuring Digi devices.

Configure the Digi Device from an Attached Terminal

With this method, you cable a terminal or PC running terminal emulation software to a device server port and then use the command line to enter commands. This method allows you to configure all features. It requires, however, that you and the device server be in the same location. Some users find it advantageous to configure the device server IP address this way and then use one of the other methods for the rest of the configuration.

Important: You cannot configure the Digi device from an attached terminal if you are using SP and DOIA. The device type has changed from terminal to printer, which no longer allows access through the serial port when SP and DOIA are set to factory defaults.

Configure the Digi Device from a Telnet Session

With this method, you Telnet to the device server and use the command line to complete configuration tasks. The only disadvantage to this method is that you have to configure the device server with an IP address before you can Telnet to it.

Configure the Digi Device from the Web Interface

The great advantage to this method is ease of use. This method requires that you configure the IP address before you can access the configuration from the web interface, however, some features cannot be configured this way.

Downloading a Configuration File

With this method, you configure a Digi device and then do the following:

1. Download an existing configuration file to a host system.
2. Edit the file with specific configuration using a text editor.
3. Upload the file to the device server.

This an excellent method for maintaining highly similar configuration files for multiple Digi devices. The disadvantage is that the device server requires some configuration steps, such as the IP address, to be completed before it can be used.

Accessing the Configuration from the Web Interface

To access the configuration from the web interface, follow these steps.

This procedure assumes that you have configured the Digi device with an IP address already. See "Configure the IP Address" on page 11.

1. Access the Digi device from a web browser by specifying the device server's IP address in the URL window.
2. Log on as `root`. The default password is `dbps`.

Quick Reference for Configuring Features

This table is a quick reference for configuring features and performing device tasks, the Digi devices in which the features are supported, and where to find them in the Web user interface.

Some features are configurable from the command line interface only. In those cases, the commands that configure the feature are noted. The command descriptions are in the *Digi One and PortServer TS Family Command Reference*.

Feature/Task	Digi Devices supported in	Web User Interface Path to Feature
Autoconnection	All	Configuration > Serial Ports > <i>port</i> > Port Profile > TCP Sockets
Configuration management:		
• Backup/restore Configuration	All	Administration > Backup/Restore
• Upgrade firmware	All	Administration > Update Firmware
• Copy configuration to and from a remote host	All	Administration > Backup/Restore > TFTP Server
• Reset configuration to defaults	All	Administration > Factory Defaults
Domain Name Server (DNS)	All	System > System Name
Embedded Modem	PortServer TS M MEI Family	Configuration > Serial Ports > <i>port</i> > Port Profile > Internal Modem Profile

Quick Reference for Configuring Features

Feature/Task	Digi Devices supported in	Web User Interface Path to Feature
Industrial Automation (IA):		
<ul style="list-style-type: none"> Protocol conversion between Modbus, Allen-Bradley, and ASCII device 	Digi One IAP Digi One IAP Haz	Applications > Industrial Automation > “launch Industrial Automation Wizard” Running the Industrial Automation Wizard is the recommended method for initial configuration of any IA equipment. See the online help for the Wizard and this web page: http://www.digi.com/applications/industrialautomation/index.jsp .
<ul style="list-style-type: none"> Allen-Bradley Ethernet-to-Serial Bridging 	Digi One IAP Digi One IAP Haz	
<ul style="list-style-type: none"> Omron Hostlink Multi-Master 	Digi One IAP Digi One IAP Haz	
<ul style="list-style-type: none"> Modbus Ethernet-to-Serial Bridging 	Digi One IA Digi One IAP Digi One IAP Haz PortServer TS Family	
<ul style="list-style-type: none"> Custom (user-defined) Multi-Master Protocol 	Digi One IAP Digi One IAP Haz PortServer TS Family	
IP routing	All	Configurable from command line only. The commands to configure IP routing are “set route” and “set forwarding.”
MEI	PortServer TS 8/16 MEI Family	Configuration > System > MEI (only maximum baud rate is configurable) Configuration > Serial Ports > <i>port</i> > MEI Serial Settings
Modem emulation	Digi One SP Digi One IA PortServer TS Family	Configuration > Serial Ports > <i>port</i> > Port Profile > Modem Emulation See the <i>Digi One and PortServer TS Family Command Reference</i> for modem emulation commands.
Port buffering	PortServer TS Family	To enable port buffering: Configuration > Serial Ports > <i>port</i> > Console Management Profile or Configuration > Serial Ports > <i>port</i> > Advanced Serial Settings To display contents of a port buffer: Management > Serial Ports > Port Logs
Port logging	Digi One IAP Digi One IAP Haz PortServer TS Family	Configuration > Serial Ports > <i>port</i> > Advanced Serial Settings > Enable Port Logging
Port profiles	All devices that support the default Web user interface	Configuration > Serial Ports > <i>port</i> > Port Profile

Feature/Task	Digi Devices supported in	Web User Interface Path to Feature
Port sharing: allowing more than one client to open a serial port through RealPort, reverse Telnet, reverse SSH, or connect.	All; console menu feature available on PortServer TS Family devices only.	By choosing the Console Management port profile for a serial port: Configuration > Serial Ports > <i>port</i> > Port Profile > Console Management or By the Advanced Serial Settings: To configure port sharing: Configuration > Serial Ports > <i>port</i> > Advanced Serial Settings > Enable multiple systems to simultaneously connect
Power Features:		
<ul style="list-style-type: none"> Power through Integrated Remote Power Management (Digi RPM) 	PortServer TS Family	To configure Digi RPM: Serial Ports > <i>port</i> > Port Profile > Power Management To manage Digi RPM: Management > Power
<ul style="list-style-type: none"> Power Over Ethernet (POE) 	Digi One IAP PortServer TS P MEI Family	This is a hardware feature. There are no configurable software settings for this feature.
<ul style="list-style-type: none"> Power Over Ports/Power Over Serial 	PortServer TS P MEI Family	This is a hardware feature. Enabling it involves changing a jumper inside the device. To display the status of the circuit breaker and reset as needed, Administration > Device Information > Serial Ports & Diagnostics > <i>port</i>
PPP (Point-to-Point Protocol)	PortServer TS Family	Applications > PPP
RealPort	All	Configuration > Serial Ports > <i>port</i> > Port Profile > RealPort Profile See also the RealPort Setup Guides for details on configuring RealPort.
Remote login (rlogin)	All	Users > <i>user</i> > User Settings > Access Method Users > <i>user</i> > Advanced Settings For ports configured with the TCP Sockets port profile, the TCP Client settings: Configuration > Serial Ports > <i>port</i> > Port Profile > TCP Sockets > TCP Client
Revert configuration settings	All	To revert all device settings, with the option to keep IP address settings: Administration > Factory Default Settings To revert serial port settings for a serial port, including port-specific security settings: Configuration > Serial Ports > <i>port</i> > Restore Factory Serial Port Settings

Quick Reference for Configuring Features

Feature/Task	Digi Devices supported in	Web User Interface Path to Feature
Security, users, and access control features:		
<ul style="list-style-type: none"> Control user access to configuration settings 	All	Configuration > Users > New User > <i>determine level of user access</i>
<ul style="list-style-type: none"> Control user access methods, including user access to the command line, automatic user connections to the device, or use of custom menus 	All	Configuration > Users > <i>user</i> > User Settings > Access Method
<ul style="list-style-type: none"> Control user access to inbound and outbound ports 	All	Configuration > Users > <i>user</i> > User Settings > Manage Serial Ports
<ul style="list-style-type: none"> Use CHAP authentication for PPP users 	All	Applications > PPP > Incoming PPP Connection and Outgoing PPP Connection
<ul style="list-style-type: none"> Use RADIUS to authenticate users 	PortServer TS Family	Configuration > Security > RADIUS
<ul style="list-style-type: none"> Issue user passwords 	All	Configuration > Users > <i>user</i> > Require password to login
<ul style="list-style-type: none"> Configure SSH Version 2 for secure communication 	Digi One IAP Digi One IAP Haz PortServer TS Family	To enable SSH and Reverse SSH: Configuration > Security > Network Security To use a public key: Configuration > Users > <i>user</i> > Advanced Settings > Enable SSH Public Key Authentication To make reverse SSH connections to ports: "ssh <i>base_port</i> + 500 + <i>port_number</i> "
<ul style="list-style-type: none"> Configure a custom menu to be displayed to a user 	PortServer TS Family	To create a custom menu: Configuration > Users > Menu button > New Menu button > Menu Settings To associate a custom menu with a user: Configuration > Users > <i>user</i> > User Settings > Custom Menu & Menu Name
<ul style="list-style-type: none"> Automatically connect a user 	All	Configuration > Users > <i>user</i> > Access Method > Automatically connect to a network service
<ul style="list-style-type: none"> Delete a user definition 	All	Configuration > Users > <i>user</i> > Remove Note that the "root" user cannot be deleted.
<ul style="list-style-type: none"> Set common user features (user attributes) 	All	Configuration > Users > <i>user</i> > User Settings
<ul style="list-style-type: none"> Use a RADIUS server to set user attributes 	PortServer TS Family	Configuration > Security > RADIUS

Feature/Task	Digi Devices supported in	Web User Interface Path to Feature
Simple Network Management Protocol (SNMP)	All	Configuration > System > SNMP
TCP Socket Communication	All	Configuration > Serial Ports > <i>port</i> > Port Profile > TCP Sockets
Time-related features, including Simple Network Time Protocol (SNTP) client configuration	PortServer TS 8/16 Family PortServer TS 8/16 MEI Family	Configuration > System > Date/Time
UDP Socket Communication	All	Configuration > Serial Ports > <i>port</i> > Port Profile > UDP Sockets
Web interface, including idle timeout for	All devices that support the default Web user interface	Configuration > System > Web Interface
Wireless devices	PortServer TS W MEI Family	Network > Network Configuration > Wireless LAN Settings

The next step in the device setup process is to configure the network and serial port settings, using the Web user interface for your Digi product.

Assumptions

To access the web interface, an IP address must be assigned to your Digi product, as described in Chapter 2, "Configure the IP Address". This chapter assumes that you have logged onto the web interface using the username, `root`, and password, `dbps`, in order to make any changes or additional configuration assignments. However, it is important to note that if you have used the Digi Device Setup Wizard, your configuration is complete and you do not need to make additional changes.

Network Settings

1. Click **Network** to view the IP settings or make any changes to the IP address.

[Help](#)

Network Configuration

IP Settings

Obtain an IP address automatically using DHCP *

Use the following IP address:

* IP Address:

* Subnet Mask:

Default Gateway:

* Changes to DHCP, IP address and Subnet Mask require a reboot to take effect.

[DNS Settings](#)

[Advanced Network Settings](#)

2. In the **Name Server** box, enter the IP address for the DNS server. The DNS server maps names (example: MyDeviceName.mycompany.com) to IP addresses (example:192.105.1.2).
3. Enter the domain name that this device will live in that is tied to the DNS server address assigned in step 2. This name can be used by other network devices to talk to it, instead of using the its IP address. Get this name from the network administrator, because it must be entered in the DNS server to work properly.

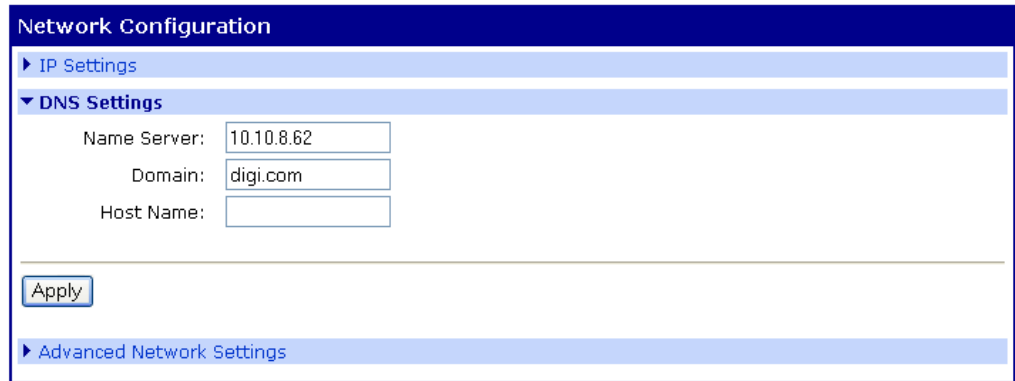

Network Configuration

▶ IP Settings

▼ DNS Settings

Name Server:

Domain:

Host Name:

▶ Advanced Network Settings

4. Enter a host name for a group of network devices.
5. Enter the Base Socket. The base socket determines the network port (socket) on this Digi terminal server that another network device (such as another Digi terminal server or a PC) uses to communicate using the Digi device's serial port services. These services include Telnet, raw TCP/UDP, and SSL.

Most applications can leave this value unchanged. To calculate these settings:

- Telnet port = Base Socket + Serial Port Number
- Raw port = Base Socket + 100 + Serial Port Number
- SSL port = Base Socket + 600 + Serial Port Number

For example:

Service	Base Socket	Network Port
telnet	2000	2001
raw (TCP or UDP)	2000	2101
SSL	2000	2601

6. Click **Apply**.
7. Click **Reboot** for changes to take effect.

Advanced Network Settings

WARNING!!!! Changing the Advanced Network Settings could cause you to 'lose' your device on the Network. If you alter these network settings - you may need to reset your device with the reset button and reconfigure your device as if it were new. See "Reset Configuration to Factory Defaults" on page 103 for instructions.

The following screen shot is for informational purposes. It is recommended that you do NOT alter the Advanced Network Settings.

Be advised these network settings are correct for most environments.

The screenshot displays the 'Network Configuration' web interface. The 'Advanced Network Settings' section is expanded, showing the following configuration:

- Ethernet Interface:** Speed: Auto, Mode: Half-Duplex
- TCP/IP Settings:**
 - TCP Time-To-Live: 64 hops
 - IP Time-To-Live: 64 hops
 - Probe Interval: 75 secs
 - Probe Count: 10
 - Retransmission Timeout: 240 secs
- TCP Keepalive Settings:**

The following TCP Keepalive settings are currently set by the DHCP server that assigns your network settings. To manually set and override these settings, select to *Ignore TCP Keepalive settings from DHCP* and reboot.

 - Ignore TCP Keepalive settings from DHCP
 - Enable TCP Keepalive
 - Idle Timeout: 2 hrs 0 mins 0 secs
 - Store extra byte in TCP Keepalive packets
- DHCP Settings:**
 - Enable Custom Identifier
 - Custom Identifier: \x00\x40\x3D\x28\xDB\x24
 - Enable Client FQDN (DHCP Option 81)
- Network Service Settings:**
 - Base Socket: 2000
 - RealPort TCP Port: 771
 - Secure RealPort TCP Port: 1027
- Miscellaneous Settings:**
 - Telnet Break: Standard

An 'Apply' button is located at the bottom left of the configuration area.

Configure Serial Ports

1. Under **Configuration**, click **Serial Ports**.
2. Click the port number that you want to configure.

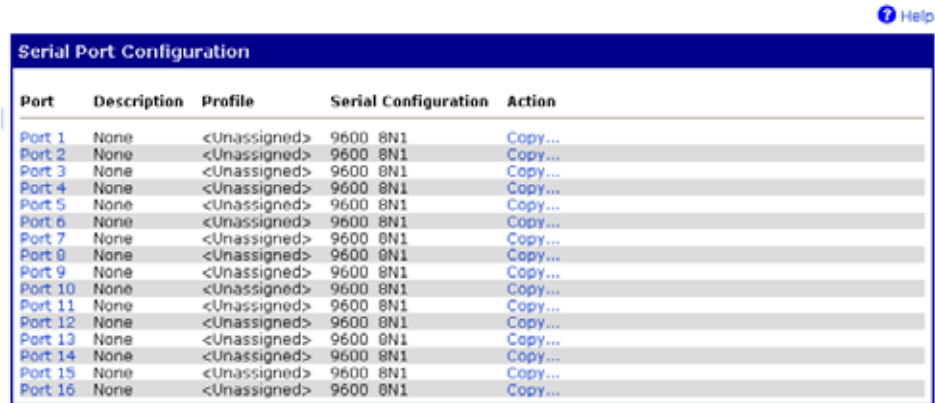

Port	Description	Profile	Serial Configuration	Action
Port 1	None	<Unassigned>	9600 8N1	Copy...
Port 2	None	<Unassigned>	9600 8N1	Copy...
Port 3	None	<Unassigned>	9600 8N1	Copy...
Port 4	None	<Unassigned>	9600 8N1	Copy...
Port 5	None	<Unassigned>	9600 8N1	Copy...
Port 6	None	<Unassigned>	9600 8N1	Copy...
Port 7	None	<Unassigned>	9600 8N1	Copy...
Port 8	None	<Unassigned>	9600 8N1	Copy...
Port 9	None	<Unassigned>	9600 8N1	Copy...
Port 10	None	<Unassigned>	9600 8N1	Copy...
Port 11	None	<Unassigned>	9600 8N1	Copy...
Port 12	None	<Unassigned>	9600 8N1	Copy...
Port 13	None	<Unassigned>	9600 8N1	Copy...
Port 14	None	<Unassigned>	9600 8N1	Copy...
Port 15	None	<Unassigned>	9600 8N1	Copy...
Port 16	None	<Unassigned>	9600 8N1	Copy...

3. Click **Change Profile** and select a profile based on the device you have connected to your port.

If this is the first profile assigned or if the unit has been restored to factory defaults, the interface will take you directly to the port profile page. The following section shows the settings available for each profile.

Select Port Profile...

You have currently not assigned a profile to this serial port. Profiles allow you to easily configure serial ports by only displaying those items that are relevant to the current profile.

Select the profile below that best matches your configuration.

- RealPort**
The RealPort Profile allows you to map a COM or TTY port to the serial port. [More...](#)
- Console Management**
The Console Management Profile allows you to access a device's console port over a network connection. [More...](#)
- TCP Sockets**
The TCP Sockets Profile allows a serial device to communicate over a TCP network. [More...](#)
- UDP Sockets**
The UDP Sockets Profile allows a serial device to communicate using UDP. [More...](#)
- Serial Bridging**
The Serial Bridging Profile configures one side of a serial bridge. A bridge connects two serial devices over the network as if they were connected with a serial cable. [More...](#)
- Printer**
The Printer Profile allows you to connect a printer to the serial port. [More...](#)
- Terminal**
The Terminal Profile allows you to connect a terminal to the serial port. [More...](#)
- Industrial Automation**
The Industrial Automation (IA) Profile allows you to communicate and network-enable various IA devices and PLCs. [More...](#)
- Modem Emulation**
The Modem Emulation Profile allows you to configure the serial port to act as a modem. [More...](#)
- Modem**
The Modem Profile allows you to connect a modem to the serial port in order to establish or receive connections from other systems and modems. [More...](#)
- Power Management**
The Power Management Profile allows you to control and manage a power controller to turn on and off outlets and devices. [More...](#)
- Custom**
The Custom Profile is an advanced option to allow full configuration of the serial port. [More...](#)

The available port profiles depend on supported by your Digi device. For example, if your Digi product does not support Power Management or Wireless capabilities, port profiles for those features will not be displayed. To verify whether your device supports a particular feature, see the "Quick Reference for Configuring Features" on page 19.

The **More** link provides additional details about each profile.

4. Click **Apply** to save the profile. The interface will determine any additional settings and port options page will come up and ask for additional parameters if needed. See "Port Profiles" on page 30 or click **Help** for additional information.
5. Enter the appropriate parameters and click **Apply**.
6. Click **Reboot** for changes to take effect.

Port Profiles

Each port profile determines the settings needed. Following are overviews of the port profiles and screen shots showing their settings. For more details about the port profile settings, click the **Help** link.

RealPort Port Profile

Installed on a network-based PC, RealPort emulates a serial port. That is, the application “thinks” it is working with a real serial port, such as COM1. When the application sends data to this serial port, RealPort encapsulates the data and ships it across the network to the Digi device which in turn routes it to the serial device. This is also referred to as COM Port Redirection. The network is transparent to both the application and the device.

With RealPort, SSL encryption is supported in network port 1027. Standard RealPort service is on network port 771. Both can be configured on the Advanced Network Settings page. To use SSL encryption, you must have a RealPort driver that supports SSL. For Unix and Linux, you can use one of these drivers: Linux, Solaris, AIX, SCO Openserver 5.x and 6, and HP-UX. With Windows, you can use the Win2k/Xp/2003 driver online, which supports Encrypted RealPort (OpenSSL/TLS1.0 128-bit AES).

A simple challenge/response MD5 hash authentication is also supported by the Windows driver on fs1.

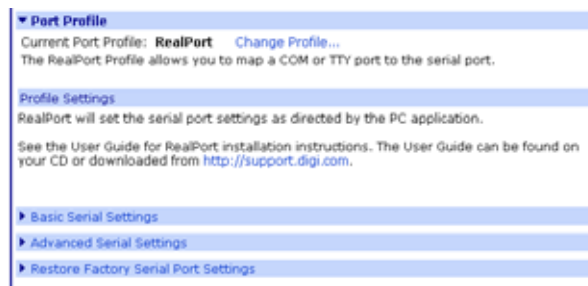

Console Management Port Profile

Console Management involves accessing a device's console port over a network connection. Most network devices such as routers, switches, and servers offer serial port(s) for management. Instead of connecting a terminal to the console port, cable the console port to the serial port of your Digi device. Then using Telnet features, network administrators can access these consoled serial ports from the LAN by addressing the appropriate TCP port.

Under Console Management you may also enable port sharing. Port sharing allows multiple users to access the port at the same time. If port sharing is disabled, then only one user may access the port at a time. You may change the number of users at any time. If you increase the number of users from 2, the change takes effect immediately. If you decrease the number of users, the change does not take effect until the users log off. For example, if port sharing is available for 9 with 9 users on, then changed to 2, the change will not take effect until at least 2 users log off. If port sharing is enabled for 2 and then disabled, the change will not take effect until everyone is off. The default value when port sharing is disabled is one.



TCP Sockets Port Profile

The Digi device supports TCP socket communication. TCP socket communication enables serial devices to communicate with each other over an Ethernet network as though they were connected by a serial cable.

Configuring TCP socket communications involves configuring the Digi device for the following types of connections:

- Inbound connections, that is, connections that are initiated by the device on the other side of the network.
- Outbound connection, that is, connections that are initiated by the device connected to the serial port.

TCP Sockets profile is also the profile to use for Autoconnection. See "Autoconnection" on page 53 for more information.

The screenshot shows a configuration window titled "Port Profile" with a sub-header "TCP Sockets". It displays the current profile and provides settings for both TCP Server and TCP Client modes.

Port Profile
Current Port Profile: **TCP Sockets** [Change Profile...](#)
The TCP Sockets Profile allows a serial device to communicate over a TCP network.

Profile Settings

TCP Server
Connect to the following TCP ports on the network (calculated from [Base Socket](#)).

Telnet TCP Port: 2001
Raw TCP Port: 2101

TCP Client
Automatically establish TCP connections to a server or other networked device.

Automatically establish TCP connections

Connect: Always
 When data arrives
 When DCD goes high

Connect To:

Service:

TCP Port Number:

Connect As:

Flush Start Character:

Send Keepalive Packets:

UDP Sockets Port Profile

The Digi device is capable of UDP multicast. UDP multicast is used to send serial data over an Ethernet cable to one or many hosts at the same time. UDP does not need a protocol because it sends data without any form of acknowledgment of error or error correction.

The number of devices that can receive a UDP multicast varies by product.

- PortServer TS 8/16 Family: up to 16 devices can receive a UDP multicast at one time.
- All other products, including the Digi One Family and PortServer TS 1/2/4: up to 64 devices can receive a UDP multicast at one time.

Both the transmitting and receiving devices must be configured properly for UDP multicast to work.

Configuring UDP multicast communications involves configuring the Digi device for the following types of connections:

- Inbound connections, that is, connections that are initiated by the device on the other side of the network.
- Outbound connections, that is, connections that are initiated by the device connected to the serial port.

The serial parameters for two connecting devices must match. That is, if one device is set for 9600 bps, the other device must be set for the same rate.

Port Profile
 Current Port Profile: **UDP Sockets** [Change Profile...](#)
 The UDP Sockets Profile allows a serial device to communicate using UDP.

Profile Settings

UDP Server
 The serial device receives data from one or multiple systems/devices on the network using the following UDP port (calculated from [Base Socket](#)).
 UDP Port: 2101

UDP Client
 Automatically send serial data to one or more devices or systems on the network using UDP sockets.
 Send data to:

Description	Send To	UDP Port
No destinations currently configured.		
dest1	0.0.0.0	0

Send data when the following string is found

- CR (carriage return)
- CR/LF (carriage return/line feed)
- Custom string

Strip string before sending

Send data after the following number of idle milliseconds
 100 ms

Always send data after the following number of bytes
 1024 bytes

[Apply](#)

[Basic Serial Settings](#)

[Advanced Serial Settings](#)

[Restore Factory Serial Port Settings](#)

Serial Bridging Port Profile

The Digi device supports serial bridging (sometimes referred to as ‘tunneling’). A serial bridge is a network connection between two serial devices, each of which uses a device server. The serial devices “think” they are communicating with each other across a serial cable using serial communication techniques. There is no need to reconfigure the server or the serial device. Neither is aware of the intervening network.

This profile configures each side of the bridge separately. Repeat the configuration for the second Digi device using the web interface. Enter the IP address in the URL bar of your browser and follow the same procedure of the bridge specifying the IP address of the first Digi device.

The screenshot shows the 'Port Profile' configuration page for 'Serial Bridging'. At the top, it says 'Current Port Profile: Serial Bridging' with a 'Change Profile...' link. Below this is a descriptive paragraph: 'The Serial Bridging Profile configures one side of a serial bridge. A bridge connects two serial devices over the network as if they were connected with a serial cable.' The 'Profile Settings' section has two radio buttons: 'Peer-to-peer bridge' (selected) and 'Client/Server bridge'. Under 'Client/Server bridge', there are two sub-options: 'This serial device initiates connections to the other serial device' and 'This serial device receives connections from the other serial device'. There are input fields for 'Connect To:' (0.0.0.0) and 'TCP Port Number:' (0). Below these, it says 'Connect to the following TCP ports to connect to this client (receiving) device (calculated from Base Socket). Telnet TCP Port: 2001 Raw TCP Port: 2101'. At the bottom of the form is an 'Apply' button. Below the form are three expandable sections: 'Basic Serial Settings', 'Advanced Serial Settings', and 'Restore Factory Serial Port Settings'.

Printer Port Profile

The Printer port profile allows you to connect a printer to a serial port. Use this profile if you intend to print using the LPD protocol on your UNIX system.

Refer to your UNIX User Guide for tips on configuring the print spooler on your UNIX system.

The screenshot shows the 'Port Profile' configuration page for 'Printer'. At the top, it says 'Current Port Profile: Printer' with a 'Change Profile...' link. Below this is a descriptive paragraph: 'The Printer Profile allows you to connect a printer to the serial port.' The 'Profile Settings' section contains the instruction: 'Verify that the Basic Serial Settings match the settings of your serial printer.' Below this are three expandable sections: 'Basic Serial Settings', 'Advanced Serial Settings', and 'Restore Factory Serial Port Settings'.

Using the LPD Protocol

Here are some tips for configuring the print spooler on your UNIX system when you intend to print using the LPD protocol to a printer attached to device server:

- The number of copies option with `lpr` is not supported.
- Banner pages are not supported.
- The device server's DNS name or IP address is the remote system's name.
- Queue names must conform to the following conventions:
 - Begin the queue name with one of the following character strings: (a) Use ASCII if you want device server to substitute carriage return and line feed characters for each line feed the system sends. (b) Use `raw` if no substitution should be performed.
 - After the queue name, insert an underscore character and the number of the device server port to which the printer is attached.
 - If you want to use either of the following options, specify an additional underscore and then the letter that identifies the option: (a) Use `f` to append a form feed character to the end of each file in a print job (b) Use `d` to add a Ctrl-d to the end of each file in a print job. (This is often required by PostScript printers.)

Examples

String	Result
<code>ascii_1</code>	Prints to port 1 and translates CR to CR/LF.
<code>ascii_8_f</code>	Prints to port 8, translates CR to CR/LF and prints a form feed at the end of the job.
<code>raw_1_d</code>	Prints to port 1 with no translation and appends a Ctrl-d to the end of the print job.

Port Profiles

Terminal Port Profile

This profile allows you to connect a terminal to the serial port. It also allows you to automatically establish TCP connections, enabling the connection to a system or a device on the network when data arrives.



The screenshot shows a configuration window titled "Port Profile". At the top, it indicates the "Current Port Profile: Terminal" and provides a "Change Profile..." link. Below this, a descriptive sentence states: "The Terminal Profile allows you to connect a terminal to the serial port." The main section is titled "Profile Settings" and contains the following fields and options:

- Terminal Type:
- Automatically establish TCP connections when data arrives
 - Connect To:
 - Service:
 - TCP Port Number:
 - Connect As:
 - Flush Start Character:
 - Send Keepalive Packets:

At the bottom of the settings area is an "Apply" button. Below the settings area are three expandable sections: "Basic Serial Settings", "Advanced Serial Settings", and "Restore Factory Serial Port Settings".

Industrial Automation Port Profile

Important: Before using the Industrial Automation port profile, consider using the IA Wizard instead. The IA Wizard is the recommended method for configuring your device for use with Industrial Automation applications. It guides you through common IA scenarios and configures your Digi device. To launch the IA Wizard from the Web user interface, under **Applications**, select **Industrial Automation**, then click **IA Wizard**.

The Industrial Automation (IA) Profile allows you to connect IA devices and PLCs (programmable logic controller) to the serial port in order to network-enable the devices. Use this profile if you need to communicate over the network with an IA device or PLC that only uses serial protocols. This profile may also be used to add routing capabilities to IA devices or PLCs that act as serial masters and send packets to various systems or devices on the network. Industrial Automation enhances the IA device or PLC connected to the serial port. Use the **Help** button for more assistance configuring this profile.

▼ Port Profile
 Current Port Profile: **Industrial Automation** [Change Profile...](#)
 The Industrial Automation (IA) Profile allows you to communicate and network-enable various IA devices and PLCs

Profile Settings

Current Protocol: **User Defined Serial Slave** [Change Protocol...](#)
 My PLC or other IA device is connected to this serial port and needs to communicate with another PLC, device, or system on the network.

▼ User Defined Settings

User Defined Protocol Settings:

Start Delimiter:

End Delimiter:

Message Timeout: ms

Process ANSI Escape Characters

[Apply](#)

▶ Basic Serial Settings

▶ Advanced Serial Settings

▶ Restore Factory Serial Port Settings

Select IA Protocol...

Please select the best matching scenario that closely matches your environment:

Serial Slave: My device or PLC accepts incoming requests from other systems, often referred to as masters. My PLC, then, acts as a slave device. This scenario accepts connections over the network or through a serial bridge using RealPort (COM port redirection).

Serial Master: My device or PLC initiates connections and sends requests to one or more systems, often referred to as slaves. My PLC, then, acts as a master. This scenario uses routing to determine where to send requests, which can be a device on a different serial port, another Digi device acting as a serial bridge between two serial PLC's, or any other networked device.

[Apply](#) [Cancel](#)

Configure Industrial Automation with Modbus

1. Click **Serial Port > Change profile** and select **Industrial Automation**.
2. Click **Apply**.
3. Under Profile settings, click **Change protocol -(Master or Slave)**.
4. Select the serial protocol that your device expects to communicate on.
The only option is User defined. The User Defined IA serial protocol is useful for devices or PLCs that do not use any of the predefined protocols and have a protocol that conforms to the following criteria: All message packets are bounded by fixed header and trailer strings Every protocol request is followed by a single response.
5. Use the **Help** button for additional information.
6. Click **Apply**.

Configure the serial port for the serial communication parameters (baud rate, data bits, parity and stop bits) required by the connected IA device. If you configure the port for a slave, you do not have to configure a network-based master. Communication with the master simply works. However, if the master is connected to a serial port, it must be configured. If you configure a port for a master and the slaves are located on the network, TCP sockets, UDP sockets, and Modbus/TCP are all supported. Use the protocol required by the master.

Chat Mode Port Profile

This configuration allows multiple clients to simultaneously connect to or manage a server connected to the same serial port, similar to a chat room. In chat mode, the serial device can be a slave or a master. Enabling the device as a server (slave) allows you to establish the end of line detection, the timeouts, and the disconnect conduct. Server settings establish the data echo direction. As a client (master) device, the same settings apply but you may also direct your communication to a specific port or other networked device.

Current Port Profile: **Chat Mode** [Change Profile...](#)
The Chat Mode Profile is used to allow multiple clients to simultaneously connect to or manage a server connected to the same serial port similar to a chat room.

Profile Settings

Select the type of Chat that the serial device connected to this serial port uses. If the serial device is a client that sends messages to a server on the network or connected to another serial port, select Client. If this serial device is the server that other clients on the network or serial ports communicate with, select Server.

Chat Mode Settings

Chat Mode:

- Serial device acts as a client device (serial master)
- Serial device acts as the server device (serial slave)

End of Line Detection:

- Automatically detect end of line
- Carriage Return (CR)
- Line Feed (LF)
- Carriage Return/Line Feed (CRLF)
- Line Feed/Carriage Return (LFCR)
- End line when Character Timeout expires
- Custom Pattern

End Delimiter:

Character Timeout (idle timeout between characters):
 ms

Disconnect idle clients when no new data received:
 s

Port Profiles

Modem Port Profiles

There are 3 types of modem port profiles:

- Modem Emulation
- Modem
- Internal Modem

Modem Emulation Port Profile

The Modem Emulation port profile allows you to configure the serial port to *act* as a modem. The Digi device *emulates* modem responses to a serial device and seamlessly sends and receives data over an Ethernet network instead of a PSTN (Public Switched Telephone Network). The advantage for a user is the ability to retain legacy software applications without modification and use a less expensive Ethernet network in place of public telephone lines.

For more details about modem emulation and descriptions of the commands that can be issued, see the chapter of the *Digi One and PortServer TS Family Command Reference* titled “Modem Emulation Commands.”



Modem Port Profile

The Modem port profile configures the Digi device for attaching a modem to the serial port in order to establish or receive connections from other systems and modems.

The screenshot shows the 'Port Profile' configuration window. At the top, it indicates the 'Current Port Profile: Modem' with a 'Change Profile...' link. Below this, a descriptive text states: 'The Modem Profile allows you to connect a modem to the serial port in order to establish or receive connections from other systems and modems.' The 'Profile Settings' section contains three radio buttons: 'Incoming Connection', 'Outgoing Connection', and 'Network Bridge Connection (bi-directional)', with the latter being selected. There is also an unchecked checkbox for 'Enable PPP Connections on this Modem', with a note below it: 'Use PPP Configuration to configure incoming or outgoing PPP connections that use this serial port.' An 'Apply' button is located below the settings. At the bottom, there are three expandable sections: 'Basic Serial Settings', 'Advanced Serial Settings', and 'Restore Factory Serial Port Settings'.

If the attached modem uses PPP connections, select Enable PPP Connections on this Modem and click the PPP Configuration link to set up incoming, outgoing or advanced PPP settings. See "System Configuration" on page 48 for more information about PPP settings.

The screenshot shows the 'System Configuration' window. The 'PPP' section is expanded, showing 'Basic PPP Settings'. There is an unchecked checkbox for 'Enable Dynamic IP Address Pool for Incoming Connections'. Below this, there is a text input field for 'First IP Address' containing '0.0.0.0' and a dropdown menu for 'Number of Addresses' set to '16'. An 'Apply' button is located below the settings. At the bottom, there are four expandable sections: 'Incoming PPP Connections', 'Outgoing PPP Connections', 'Advanced PPP Settings', and 'SNMP'.

Port Profiles

Internal Modem Port Profile

The Internal Modem port profile is used for the serial ports that contains the embedded modem. This profile allows you to configure the modem port. This profile configures the internal modem for PPP connections.

The screenshot shows a window titled "Serial Port Configuration - Port 1" with navigation buttons "Return to Serial Ports", "Previous", and "Next". The "Port Profile" section is expanded, showing the current profile as "Internal Modem" with a "Change Profile..." link. A descriptive text states: "The Internal Modem Profile is used for serial ports that contain an internal modem in order to configure both the serial port and the modem." Below this is the "Profile Settings" section, which includes "Modem Application" options: "Console Login", "Outgoing Connection", "Network Port (PPP)" (selected), "Outgoing Connection", "Incoming Connection", and "Network Bridge (bi-directional)". The "Modem Settings" section has an "Init string:" field containing "ATS0=1". An "Apply" button is located below the settings. At the bottom, there are three expandable sections: "Basic Serial Settings", "Advanced Serial Settings", and "Restore Factory Serial Port Settings".

Power Management Port Profile

The Power Management port profile allows you to connect the serial port to a power controller, such as the Digi Remote Power Manager (Digi RPM). The Digi device will monitor the power controller to provide the status and control of power outlets. This feature is used most commonly in a console management application, where the console port of a server is connected to one serial port of the Digi device for remote access, and the AC power plug of the server is connected to a power controller for AC power control.

Port Profile
Current Port Profile: **Power Management** [Change Profile...](#)
The Power Management Profile allows you to control and manage a power controller to turn on and off outlets and devices.

Profile Settings

Controller Settings

Automatically Detect Power Controller
 Manually Configure Power Controller

Manufacturer:
 Outlets:

Thresholds (Only Configurable when Controller is Connected):
 Current Alarms (amps):
 Temperature (°C):

[Controller Outlets](#)
[Basic Serial Settings](#)
[Advanced Serial Settings](#)
[Restore Factory Serial Port Settings](#)

Port Profile
Current Port Profile: **Power Management** [Change Profile...](#)
The Power Management Profile allows you to control and manage a power controller to turn on and off outlets and devices.

Profile Settings

Controller Settings

Automatically Detect Power Controller
 Manually Configure Power Controller

Manufacturer:
 Outlets:

Thresholds (Only Configurable when Controller is Connected):
 Current Alarms (amps):
 Temperature (°C):

[Controller Outlets](#)
[Basic Serial Settings](#)
[Advanced Serial Settings](#)
[Restore Factory Serial Port Settings](#)

Power controller settings can be automatically detected or configured manually.

For more information on integrating the Digi RPM power controller with your Digi device, see Chapter 9, "Digi Remote Power Manager (Digi RPM)".

Port Profiles

Custom Port Profile

The Custom port profile allows you to see all settings and set them accordingly. Use this profile only if your application does not fit into any of the predefined port profiles

Port Profile
Current Port Profile: **Custom** [Change Profile...](#)
The Custom Profile is an advanced option to allow full configuration of the serial port.

Profile Settings
Device Type: **Power**

TCP Server
Connect to the following TCP ports on the network (calculated from [Base Socket](#)).
Telnet TCP Port: 2001
Raw TCP Port: 2101

TCP Client
Automatically establish TCP connections to a server or other networked device.
 Automatically establish TCP connections
Connect To: 0.0.0.0
Service: Telnet
TCP Port Number: 0
Connect As: None
Flush Start Character: Auto
Send Keepalive Packets:

UDP Server
The serial device receives data from one or multiple systems/devices on the network using the following UDP port (calculated from [Base Socket](#)).
UDP Port: 2101

UDP Client
Automatically send serial data to one or more devices or systems on the network using UDP packets.
Send data to:

Description	Send To	UDP Port
No destinations currently configured.		
dest1	0.0.0.0	0

Send data when the following string is found
 CR (carriage return)
 CR/LF (carriage return/line feed)
 Custom string
 Strip string before sending

Send data after the following number of idle milliseconds
100 ms

Always send data after the following number of bytes
1024 bytes

[Apply](#)

User Configuration

Although it is not required, the device server is often configured to accommodate the requirements of particular users. Typical configurable user attributes include:

- Whether the user is required to supply a password.
- Autoconnection attributes, such as the system to which the user should be automatically connected at login.
- The interface the device presents the user, such as a menu or command line.
- Whether the user has access to outbound ports.

Users select a user profile that most closely describes the user's environment. User profiles include:

- Console Management - expected to connect to and manage serial devices that have a console port. Users can connect directly, use a custom menu interface, or reverse telnet or SSH into a serial port.
- Terminal/Terminal Emulation - using a terminal or terminal emulation program to connect to the serial port and needs to automatically connect to a device available on the network.
- Custom - using a terminal or terminal emulation program to connect to the serial port and needs to automatically connect to a device available on the network.
- With a RADIUS server. See the "set radius" command description in the *Digi One and PortServer TS Family Command Reference*.

Common User Features

Feature	Description
accesstime	Determines the times and days the user can access the device server. This feature is not configurable from the web interface.
autoconnect	Automatically connects the user to the host specified on the autohost field using the service (TCP port) defined on the autoport or autoservice fields. Autoconnection can also be implemented by port instead of by user.
Default access type	Defines the type of access the user is restricted to. Menu, command line, autoconnect, and outgoing and net service are the types.
Menu access	Defines the menu that is to be presented to a user with menu access.
Port access	Defines the number of outbound ports a user connected over the LAN can access at one time. This feature is not configurable from the web interface.
PPP	Defines PPP-related parameters for the user. For more information on configuring PPP users, see "PPP Settings" on page 49.
Routing updates	Defines whether RIP routing updates are forwarded over the link to this user.

User Configuration

Add a User

1. Click **Users > New User**.
2. Enter the Username, password, and password confirmation, and click **Next**.



3. Select the profile that fits the user's environment/needs, and click **Next**.

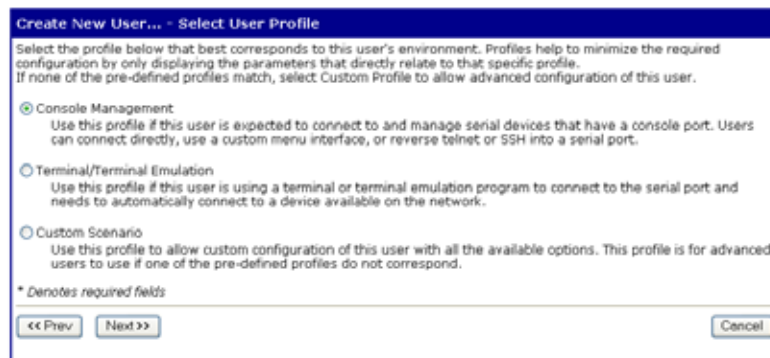

4. Select the Ports to manage or the Autoconnect function if needed and click **Next**.
5. Review settings and click **Finish**.
The Advanced tab under User allows you to set Escape characters for Connect, Telnet, Rlogin, and Kill as well as an SSH Public Key.
6. Click **Apply** to save the settings.
7. Click **Reboot** for changes to take effect.
8. User attributes can be changed after the user is set up. Select **Users > username**. From here you can change the password, the access method, the menu, or verify the user's properties.

Configure User Access Method

1. Set up the user as described in the previous procedure.
2. Click **Users > username** to assign access and select the access method or methods.
3. Select the ports for the user and click **Apply**.

Change or Update User Passwords

On the Users page, you can also change or update the users password. However, if the Admin password is lost, the only recovery is factory default reset. See "Reset Configuration to Factory Defaults" on page 103.

Security Configuration

Security settings allow the administrator to set passwords, security levels, and authentication via RADIUS server.

Enabling and Disabling Access to Network Services

Some network services, such as Telnet and Rlogin, can be disabled for inbound users. This means that the users cannot access the Digi device using those services. This feature allows you to turn off individual services or to specify a security level, which means that all services *not* included in that level are turned off. The following services can be turned off.

- SSH
- Reverse SSH
- HTTPS
- HTTP
- SNMP
- RealPort
- Secure RealPort
- Secure Sockets
- Telnet
- Remote Login (RLogin)
- Remote Shell (RSH)
- Reverse TCP
- Reverse Telnet
- Line Printer Daemon (LPD)

Configure Security Settings

1. Click **Security** > and enter a new password for the root administrator.
2. Enter the confirmation password and click **Apply**.
3. Click **Network Security**. Select the security level appropriate to your environment, and click **Apply**.

Secure Access Levels are defined as follows:

- **Secure**: SSH is the only service available to inbound users.
- **High**: SSH, HTTP, SNMP, and RealPort services are available to inbound users.
- **Normal**: all services are available.
- **Custom**, which means you can select services to turn off.

The default service level is Normal.

4. Click **RADIUS** and select **Authenticate users via RADIUS server**.
If you do not have RADIUS available, Click **Apply** and then **Reboot**.
5. Enter the Primary server's IP address and Primary server's secret, which is the password used for encryption of messages between the RADIUS server and the Digi device. Click **Apply**.
6. Click **Reboot** for changes to take effect.

System Configuration

System settings allow you to tune the performance optimizing throughput or latency, the date and time, PPP connections, SNMP traps, and Baud rates for MEI.

1. Click **System** and enter the following:
 - **System Description**: the network name assigned to the Digi device.
 - **Contact**: the SNMP contact person -often the network administrator.
 - **Location**: a text description of the physical location of the Digi device.
 - **Optimization**: the bandwidth used on the network. Options here are:
 - Latency**: Allows fast access to time-sensitive devices. Requires more network bandwidth.
 - Throughput**: Allows better network performance at higher throughput.Click **Apply**.
2. Click **Date/Time**. If your Digi device does not have Date/Time available, Click **Reboot**.
3. Enter the date and time information and click **Apply**.
4. Click **Reboot** for changes to take effect.

PPP Settings

Under System Configuration, users can set the PPP (Point-to-Point Protocol) options to enable or disable the dynamic IP address pool. The dynamic IP address pool is a set of reserved IP addresses unique to the network that are assigned to the incoming connections. Users set the first IP address to use and the number of sequential addresses (plus one) to be reserved for assignment.

Configure Incoming PPP Connections

1. Click **PPP**.
2. If you are using PPP, select **Enable Dynamic IP Address Pool for Incoming Connections**.
3. Enter the first reserved IP address of the incoming connections and the number of addresses to use and click **Apply**.
4. Click **Incoming Connections > New Connection**.

5. Enter the appropriate parameters and click **Apply**.
6. Click **Reboot** for changes to take effect.

Configure Outgoing PPP Connections

For outgoing connections, CHAP or PAP authentication, or password configuration, use the following procedure.

1. Click **Outgoing Connections**.



CHAP authentication can be used to restrict PPP user access to outbound ports.

2. Enter the appropriate parameters and click **Apply**.
3. Click **Reboot** for changes to take effect.

For dynamic routing or proxy ARP settings, follow the procedure for configuring advanced PPP settings.

Configure Advanced PPP Settings

1. Click **Advanced PPP settings**. As needed, use the **Help** button for more information about configuring advanced PPP settings.



2. Select **Enable Dynamic Routing (RIPv1)**.
3. Select the passive or active route setting.
4. Select the **Process ARP requests** if appropriate.

5. Click **Apply**.
6. Click **Reboot** for changes to take effect.

Configure SNMP Settings

1. Click **System > SNMP**.
2. Select **Enable SNMP**.
3. Enter the community (public or private).

The screenshot shows the 'System Configuration' web interface. The 'SNMP' section is expanded, and the 'Enable SNMP' checkbox is checked. Below this, there are two text input fields: 'Get Community' with the value 'public' and 'Set Community' with the value 'private'. There are six unchecked checkboxes for generating traps: 'Generate Authentication Traps', 'Generate Login Traps', 'Generate Cold Start Traps', 'Generate Link Up Traps', 'Generate Power Unit Current Threshold Traps', and 'Generate Power Unit Temperature Threshold Traps'. Below these is a 'Destination IP' field with the value '0.0.0.0'. At the bottom of the configuration area, there is an 'Apply' button. The interface also shows a navigation menu on the left with options for System, Date/Time, PPP, and MEI.

4. Select the type or types of traps you wish to enable.
5. Click **Apply**.

System Configuration

Configure MEI Settings

MEI settings apply to EIA-422/485 Half-Duplex (2 wire) ports only. See "Configure MEI Settings" on page 77 for details on MEI.

1. Select **System > MEI**.
2. Select the baud rate from the **Maximum** drop down box.
3. Select **Apply to all ports**, if appropriate.

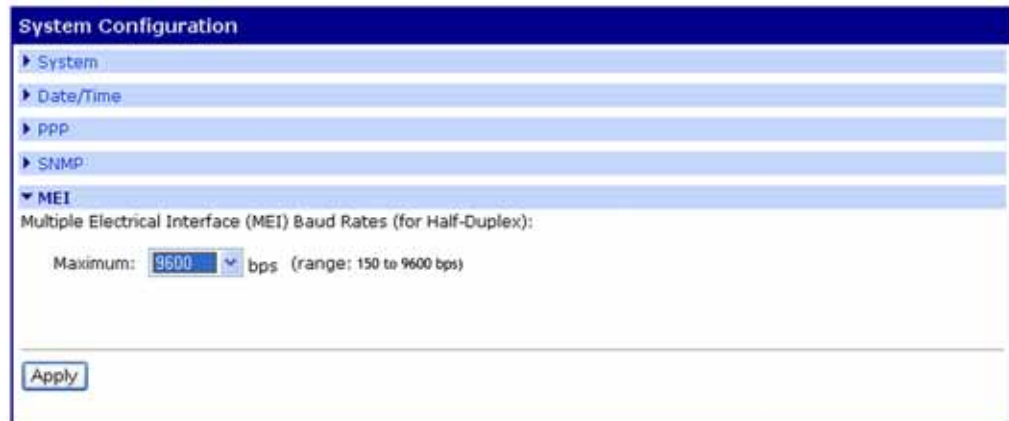

4. Click **Apply** for configuration to take effect.

Autoconnection

The autoconnection feature allows you to configure a user to access the device server and then be automatically connected to a host on the LAN. You can implement autoconnection in the following ways:

- By port, where all port users are automatically connected to the same host. The device server is completely transparent to them.
- By user, where a user is required to log on and may be required to supply a password. Once the user is authenticated, an automatic connection to a host is made.

Configure a Port for Autoconnection

1. Under **Configuration**, select **Serial Ports**.
2. Click the **TCP Sockets Port Profile**. Note that TCP Sockets is the port profile to use for Autoconnection.
3. Click **Apply**.
4. Select **Automatically establish TCP connections** and the appropriate parameters. Use the **Help** button for additional information.
5. Click **Apply**.
6. Click **Reboot** for changes to take effect.

Note: To return to the main Ports menu, choose Ports from the Menu again.

Configure a User for Autoconnection

1. Click **Users** from the menu.
2. Choose **New User**.
3. Enter a username and click **Next**.
4. Select the **Terminal/Terminal Emulation** user profile and click **Next**.
5. Select **Automatically connect to a ...**
Be sure to specify the following:
 - Hostname or IP address that will be the destination
 - Service (Telnet, Rlogin, raw TCP, or SSL)
 - Destination TCP port number, which determines the type of connection for this user (such as 23 for Telnet)
6. Click **Next** and choose to verify the settings.
7. Click **Finish** to save settings.

Configure Industrial Automation (IA)

This chapter discusses using Digi products with Industrial Automation (IA) applications, including configurations that work for your for IA applications, and the configuration tasks required to use your Digi product in an IA environment.

Key Terms in This Chapter

Industrial Automation involves several key terms:

Com Port Redirection

A method of redirecting the serial data generated by a PC-based master to a slave connected to a port on a network-based device server. In this scheme, the master “thinks” that it is communicating with a device connected to a serial port on the PC system when, in fact, the data is encapsulated in network packets and transported across the network to a device connected to a serial port on the Digi device server. Many applications, written to support serial communication only, require this service in order to communicate over the Ethernet.

IA

Abbreviation for industrial automation

master (or protocol master)

The host or IA device that initiates all communication with a protocol slave

multi-master

Any configuration in which more than one master simultaneously communicates with a slave

protocol request

A message generated by the master and sent to the slave that requests information or issues a command

protocol response

A message generated by the slave in response to a protocol request from the master

slave (or protocol slave)

The device that responds to requests from the master

TCP socket (or TCP socket service)

A type of network service that uses TCP to ensure reliability. When this manual discusses TCP sockets, it means that IA protocol messages are encapsulated in network packets and transported across the network using a standard network service. Many applications support connections to devices using TCP socket.

TCP tunnel

A TCP socket connection in which a master is connected to the serial port of one device server and a slave to the serial port of another Digi device.

UDP sockets (or UDP socket service)

Similar to TCP socket service (discussed above) except that the UDP protocol is used instead of TCP, which means that the reliability service TCP performs is not provided. Advantages of UDP socket service are slightly less protocol overhead and support for multicasting. Some applications support connections to devices using TCP socket.

UDP tunnel

A UDP socket configuration in which a master is connected to the serial port of one device server and a slave to the serial port of another Digi device.

Industrial Automation Configuration Wizard

To help you configure your Digi product for use in an IA application, a configuration wizard and several configuration profiles, or scenarios, are provided. To launch the wizard from the Web user interface, go to **Applications > Industrial Automation** and click the link in the text "For a guided installation, launch the **Industrial Automation Wizard**."

Industrial Automation Configuration Profiles

This chapter discusses several common configuration profiles for industrial automation:

- "Serial Bridge Profile: Master and Slave Connected to Digi Ports" on page 57
- "Modbus Profile: Serial-Connected Slave" on page 58
- "Modbus Profile: Serial-Connected Master" on page 59
- "Omron Family Profile: Serial-Connected Slave" on page 62
- "Omron Family Profile: Serial-Connected Master" on page 63
- "Other Serial Port Protocol Profile: Serial-Connected Slave" on page 64
- "Other Serial Port Protocol Profile: Serial-Connected Master" on page 65

Industrial Automation Configuration Procedures

This chapter presents procedures for configuring these common industrial automation configuration profiles:

- "Configure a Serial-Connected Slave: Generic Procedure" on page 66
- "Configure a Serial-Connected Master: Generic Procedure" on page 66
- "Configure a Serial-Connected Master: TCP/UDP Sockets" on page 67
- "Configure a Serial-Connected Slave: Other IA Protocol" on page 67
- "Configure a Serial-Connected Master: Other IA Protocol" on page 68
- "Set Up COM Port Redirection" on page 69

Serial Bridge Profile: Master and Slave Connected to Digi Ports

When to Use

Use this profile to connect a protocol master to the serial port of one device server and the protocol slave (or slaves) to the serial port of another device server. This profile, which is often called a serial bridge, is applicable to environments that use most IA serial port protocols and to multi-master environments as well. The network is completely transparent to the serial devices, which means they do not have to be reconfigured.

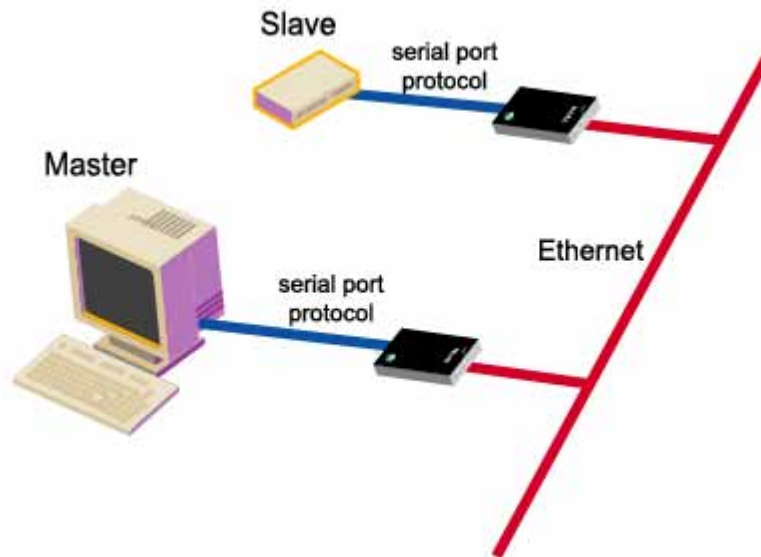

Configuration Options

The serial port connections must be configured to meet the requirements of the attached device, which can be Modbus ASCII, Modbus RTU, DF1 Full-Duplex, DF1 Half-Duplex, Omron Hostlink, Omron FINS, and Omron CompoWay/F. It can also be a serial port protocol that meets Digi's definition of a "user defined" protocol, that is, one that has fixed header and trailer strings that bound all message packets and where each protocol request is followed by a single response.

For the network connection, Digi recommends TCP sockets, which works regardless of the serial port protocol specified and provides an efficient and reliable network service. Another option is UDP sockets, which also works with all the serial port protocols, although it lacks TCP socket reliability. For Modbus devices, Modbus/TCP is an option, and for DF1 Full-Duplex devices, Allen Bradley Ethernet and Ethernet/IP are options.

Setup Information: Slave Side

See "Configure a Serial-Connected Slave: Generic Procedure" on page 66.

Setup Information: Master Side

To configure TCP socket or UDP socket communication, see "Configure a Serial-Connected Master: TCP/UDP Sockets" on page 67. To configure any of the other network communication protocols, see "Configure a Serial-Connected Master: Generic Procedure" on page 66.

Modbus Profile: Serial-Connected Slave

When to Use

Use this profile to connect a slave device (or devices) using Modbus RTU or Modbus ASCII. This profile is applicable to environments in which multiple masters will control the slave or slaves.

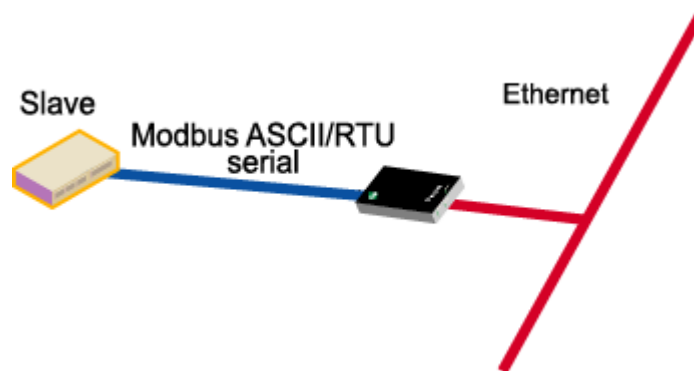

Configuration Options

The serial port connection must be configured for the protocol required by the slave, in this case Modbus RTU or Modbus ASCII.

The network connection usually does not require configuration. The only exception is if the master requires COM port redirection. In this case, the master is an application that resides on a PC, such as a Microsoft Windows system, and communicates only with devices on COM ports.

Setup Information

- To configure the serial port for Modbus ASCII or Modbus RTU, see "Configure a Serial-Connected Slave: Generic Procedure" on page 66.
- To setup a PC and the device server for COM port redirection using RealPort, see "Set Up COM Port Redirection" on page 69.

Modbus Profile: Serial-Connected Master

When to Use

Use this profile to connect a master device using Modbus RTU or Modbus ASCII to the serial port of the device server.

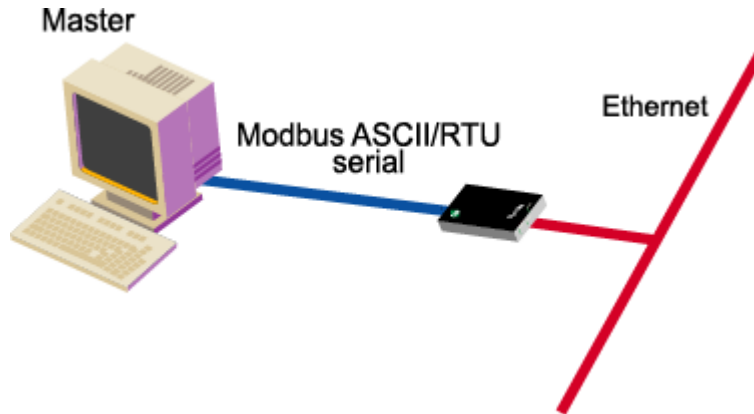

Configuration Options

The serial port connection must be configured for the protocol required by the master, in this case Modbus RTU or Modbus ASCII. If the remote slave supports TCP socket communication, which is the case if the remote slave is connected to another device server, Digi recommends this option. Modbus/TCP is the other supported network option. This master can be configured to control up to 8 slaves.

Setup Information

- To configure the port for Modbus ASCII or Modbus RTU and the network for TCP socket communication, see "Configure a Serial-Connected Master: TCP/UDP Sockets" on page 67.
- To configure the port for Modbus ASCII or Modbus RTU and the network for Modbus/TCP, see "Configure a Serial-Connected Master: Generic Procedure" on page 66.

DF1 Profile: Serial-Connected Slave

When to Use

Use this profile to connect a slave device (or devices if multiple slaves are connected) using DF1 Full-Duplex and DF1 Half-Duplex protocols.

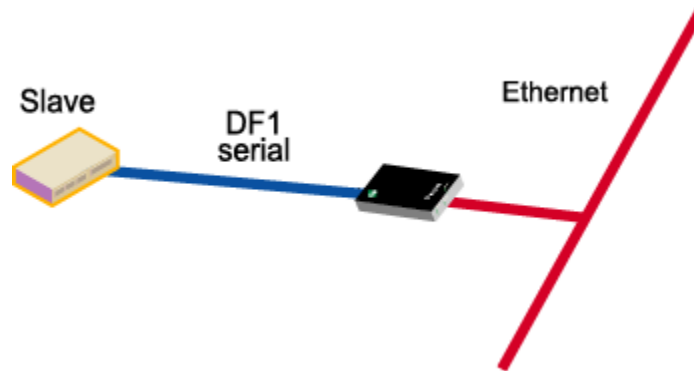

Configuration Options

The serial port connection must be configured for the protocol required by the slave, in this case DF1 Full-Duplex or DF1 Half-Duplex.

The network connection usually does not require configuration. The only exception is if the master requires COM port redirection. In this case, the master is an application that resides on a PC, such as a Microsoft Windows system, and communicates only with devices on COM ports.

Setup Information

- To configure the serial port of the device server for DF1 Full-Duplex or DF1 Half-Duplex, see "Configure a Serial-Connected Slave: Generic Procedure" on page 66.
- To set up a PC and the device server for COM port redirection using RealPort, see "Set Up COM Port Redirection" on page 69.

DF1 Profile: Serial-Connected Master

When to Use

Use this profile to connect a master device using DF1 Full-Duplex and DF1 Half-Duplex protocols to the serial port.

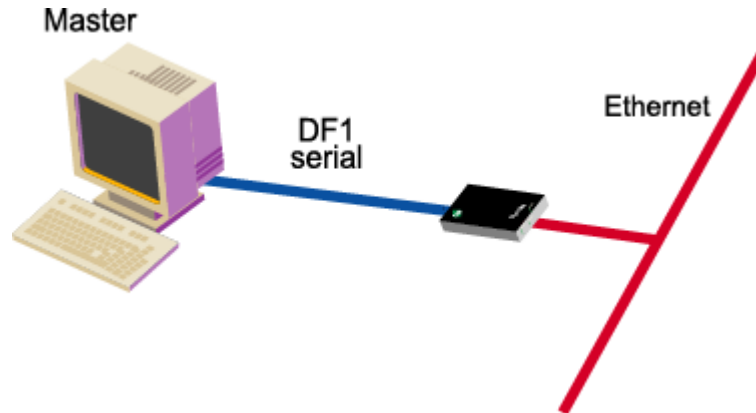

Configuration Options

The serial port connection must be configured for the protocol required by the master, in this case DF1 Full-Duplex or DF1 Half-Duplex. If the remote slave supports TCP socket communication, which is the case if the remote slave is connected to another device server, Digi recommends this option. For DF1 Full-Duplex users, Allen Bradley Ethernet and Ethernet/IP are other supported network options.

Setup Information

- To configure the port for DF1 Full-Duplex or DF1 Half-Duplex and the network for TCP socket communication, see "Configure a Serial-Connected Master: TCP/UDP Sockets" on page 67.
- To configure the port for DF1 Full-Duplex and the network for Allen Bradley Ethernet or Ethernet IP, see "Configure a Serial-Connected Master: Generic Procedure" on page 66.

Omron Family Profile: Serial-Connected Slave

When to Use

Use this profile to connect a slave device (or devices) using one of the Omron serial port protocols, Hostlink, FINS, or CompoWay/F.

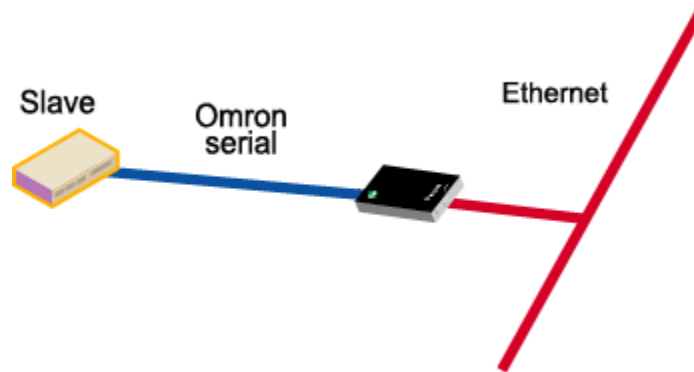

Configuration Options

The serial port connection must be configured for the protocol required by the slave, Hostlink, FINS, or CompoWay/F.

The network connection usually does not require configuration. The only exception is if the master requires COM port redirection. In this case, the master is an application that resides on a PC, such as a Microsoft Windows system, and communicates only with devices on COM ports.

Setup Information

- To configure the serial port of the device server for any of the Omron protocols, see "Configure a Serial-Connected Slave: Generic Procedure" on page 66.
- To setup a PC and the device server for COM port redirection using RealPort, see "Set Up COM Port Redirection" on page 69.

Omron Family Profile: Serial-Connected Master

When to Use

Use this profile if you want to connect a master device to the serial port using one of the Omron serial port protocols, Hostlink, FINS, or CompoWay/F.

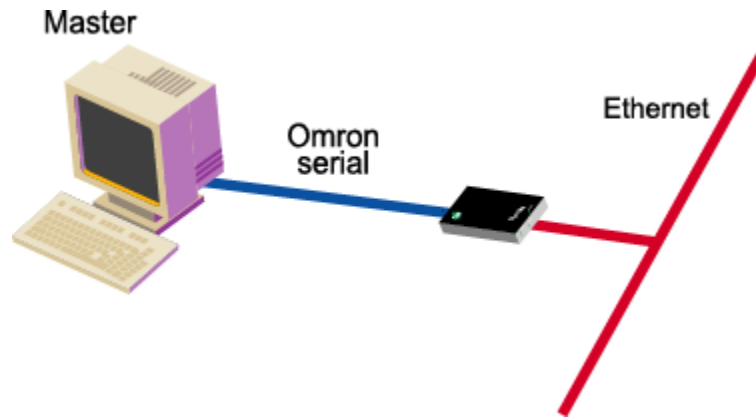

Configuration Options

The serial port connection must be configured for the protocol required by the master, in this case Hostlink, FINS, or CompoWay/F. If the remote slave supports TCP socket communication, which includes a slave connected to another device server, Digi recommends this network option. UDP Sockets is another supported network option.

Setup Information

To configure the port for one of the Omron protocols and the network for TCP or UDP socket communication, see "Configure a Serial-Connected Master: TCP/UDP Sockets" on page 67.

Other Serial Port Protocol Profile: Serial-Connected Slave

When to Use

Use this profile if you want to connect a slave device to the serial port using any IA serial port protocol not previously discussed.

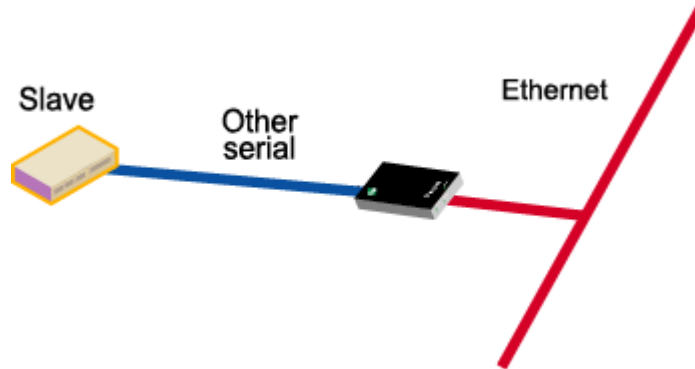

Configuration Options

In this configuration, you do not set up the port of the device server for an IA protocol. If you plan to use RealPort for COM port redirection, you simply set up the port for RealPort. If you plan to have the master access the device server using TCP or UDP sockets, you simply configure the standard serial port parameters required by the attached slave, such as line speed, number of data bits, and parity scheme. No special network configuration is required in either case.

Setup Information

- To set up the device server for RealPort, see "Set Up COM Port Redirection" on page 69.
- To set up the port for an "unsupported" IA protocol, see "Configure a Serial-Connected Slave: Other IA Protocol" on page 67.

Other Serial Port Protocol Profile: Serial-Connected Master

When to Use

Use this profile if you want to connect a master device to the serial port using any IA serial port protocol not previously discussed.

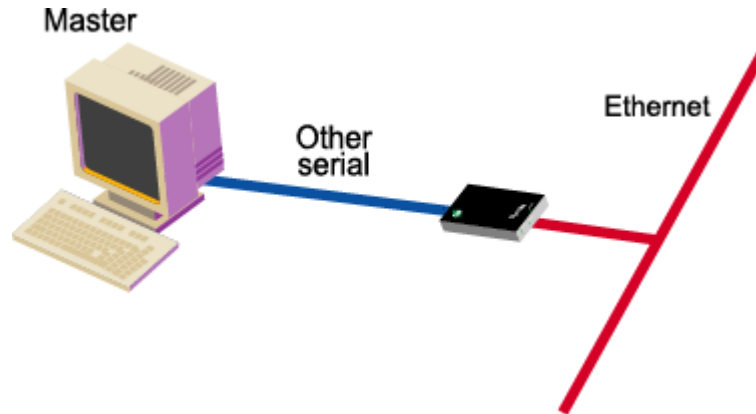

Configuration Options

In this configuration, you do not set up the port of the device server for an IA protocol. You simply configure the standard serial port parameters required by the attached master, such as line speed, number of data bits, and parity scheme and then configure the port for autoconnection.

Setup Information

See "Configure a Serial-Connected Master: Other IA Protocol" on page 68.

Configure a Serial-Connected Slave: Generic Procedure

When to Use

Use this procedure when a protocol slave is connected to the serial port of the device server. Use it except when the associated master requires COM port redirection. (See "Set Up COM Port Redirection" on page 69 for information.)

Procedure

1. Access the web interface by entering the device server IP address in a browser's URL window.
2. Log in to the device server as `root`. The default password is `dbps`.
3. From the main menu, choose **Setup Wizards > Industrial Protocols**.
4. Choose the serial port protocol required by the slave that is connected to the serial port.
5. Choose Slave as the device type.

Any number of network masters can communicate with the slave.

Configure a Serial-Connected Master: Generic Procedure

When to Use

Use this procedure when a protocol master is connected to the serial port of the device server. Use it except when the master requires TCP socket or UDP socket communication. (See "Configure a Serial-Connected Master: TCP/UDP Sockets" on page 67 for information.)

Procedure

1. Access the web interface by entering the device server IP address in a browser's URL window.
2. Log in to the device server as `root`. The default password is `dbps`.
3. From the main menu, choose **Setup Wizards > Industrial Protocols**.
4. Choose the serial port protocol required by the master.
5. Choose Master as the Mode.
6. Configure up to 8 network slaves.

Configure a Serial-Connected Master: TCP/UDP Sockets

When to Use

Use this procedure in the following situations:

- When a protocol master using one of the supported serial port protocols (Modbus ASCII, Modbus RTU, DF1 Full-Duplex, DF1 Half-Duplex, FINS, Hostlink, CompoWay/F or a protocol that meets Digi's definition of a "user-defined" protocol) is connected to the serial port.
- When the master requires TCP or UDP sockets for network communication.

Procedure

1. Access the web interface by entering the device server IP address in a browser's URL window.
2. Log in to the device server as `root`. The default password is `dbps`.
3. From the main menu, choose **Setup Wizards > Industrial Protocols**.
4. Choose the serial port protocol required by the master.
5. Choose Master as the Mode.
6. Configure up to 8 network slaves.
7. Change the default socket number only if required.

Configure a Serial-Connected Slave: Other IA Protocol

When to Use

Use this procedure in the following situations:

- When the device connected to the serial port is a slave that is using a "non-supported" serial-port protocol, that is, the serial port protocol is not Modbus ASCII, Modbus RTU, DF1 Half-Duplex, DF1 Full-Duplex, FINS, Hostlink, CompoWay/F, or a protocol that meets the definition of a "user-defined" protocol.
- When you do *not* want to set up the device server for RealPort COM Port redirection.
- When multiple masters will *not* be communicating with this slave.

Procedure

1. Access the web interface by entering the device server IP address in a browser's URL window.
2. Log in to the device server as `root`. The default password is `dbps`.
3. From the main menu, choose **Configure > Port**.
4. From the Port configuration page, set the **Device type** to **Printer**, adjust other serial port communication parameters as required by the connected slave, and click **Submit**.
5. Choose **Advanced**, check **Binary Mode**, and click **Submit**.

Configure a Serial-Connected Master: Other IA Protocol

When to Use

Use this procedure when the device connected to the serial port is a master that is using a “non-supported” serial-port protocol, that is, the serial port protocol is not Modbus ASCII, Modbus RTU, DF1 Half-Duplex, DF1 Full-Duplex, FINS, Hostlink, CompoWay/F, or a protocol that meets the definition of a “user-defined” protocol.

Procedure

1. Access the web interface by entering the device server IP address in a browser’s URL window.
2. Log in to the device server as `root`. The default password is `dbps`.
3. From the main menu, choose **Configure > Port**.
4. From the Port configuration page, set the **Device type** to **Modem In**, adjust other serial port communication parameters as required by the connected master, then choose **Submit**.
The **Terminal type** field does not matter.
5. If you want to configure the port to launch an automatic connection to the slave, click **Advanced**.
6. Choose **Enable Autoconnect**.
7. Specify the IP address of the slave.
8. Specify a TCP port to use for this connection. If this is a connection to another device server, use 2101 as the TCP port number.
9. If you want the autoconnection to launch immediately, choose **Force DCD**.
10. Choose **Binary Mode**.
11. If you want to enable UDP sockets (instead of TCP sockets), choose **UDP Serial**, use the online help for information on completing configuration task.
12. When you complete configuration, click **Submit**.

Set Up COM Port Redirection

When to Use

Use these procedures when a slave is connected to the serial port of the device server and the master, which must be an application residing on a Microsoft Windows system, requires COM port redirection.

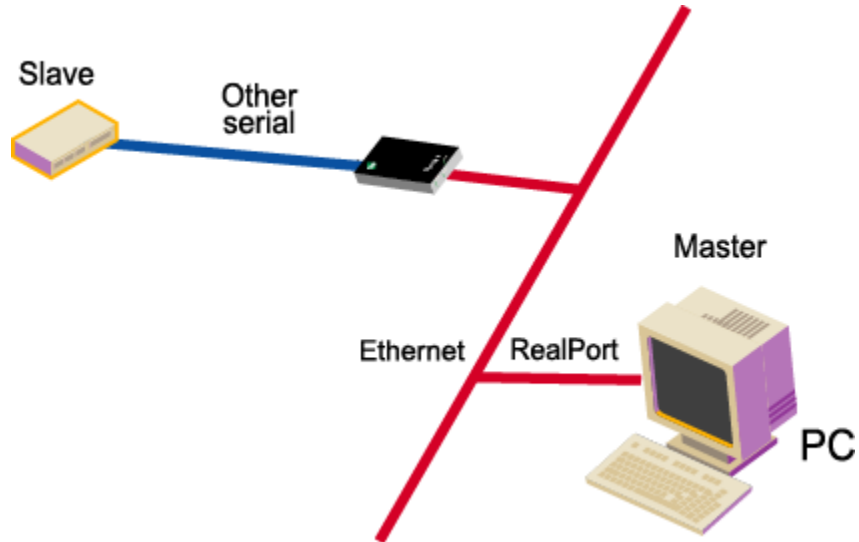

Setup Tasks: An Overview

To enable Com port redirection--which requires that RealPort software be running on the same PC as the master application--complete the following tasks:

1. Configure the serial port for RealPort.
See "Procedure: Configure the Serial Port for RealPort" on page 70.
2. Install RealPort software on a host system.
3. Configure the port on the RealPort PC.

See the PC's documentation for information on configuring serial ports.

Update POST Code

Procedure: Configure the Serial Port for RealPort

Use this topic for information on configuring the Digi device.

1. Access the Digi device configuration from a web browser by entering the device's IP address in the browser's URL window.
2. Log on to the Digi device as the `root` user as shown. The default password is `dbps`.
3. Do one of the following:

If the slave is using a supported serial port protocol	If the slave is not using a supported serial port protocol
Choose Port from the main menu. Set the Device Profile to IA. Click Apply and enter the protocol information.	Choose Setup Wizards > RealPort . Use the wizard to complete configuration.

4. Use the Add RealPort wizard and the associated help text to configure the RealPort driver with the IP address and TCP port number used by the device server.
5. Follow the prompts to complete configuration of the RealPort driver.

Update POST Code

This procedure shows you how to upgrade POST code from a file or TFTP. Typically, POST upgrades are not required and should only be done if the firmware release notes indicate that this step is required.

The preferred method is to use your web browser and download the file onto your PC. TFTP, however, is often used in UNIX environments, so TFTP is supported as well.

Prerequisite

This procedure assumes that:

- You have already downloaded the firmware file from the web site.
- TFTP is running (if you are using the TFTP option).

Procedure

1. Open a web browser and enter the device server's IP address in the URL window.
2. Log in to the device server as `root`. The default password is `dbps`.
3. Choose **Upgrade Firmware** from the main menu.
4. From the dropdown menu, select **Boot/POST**.
5. Click **Browse** to select the Boot/Post image.
6. Click **Update**.

RealPort: Determining whether to Install RealPort

Trying to decide if you need to install RealPort? Use these decision maps to help you decide. Follow the scenario closest to what you are trying to do then follow the questions for additional directions.

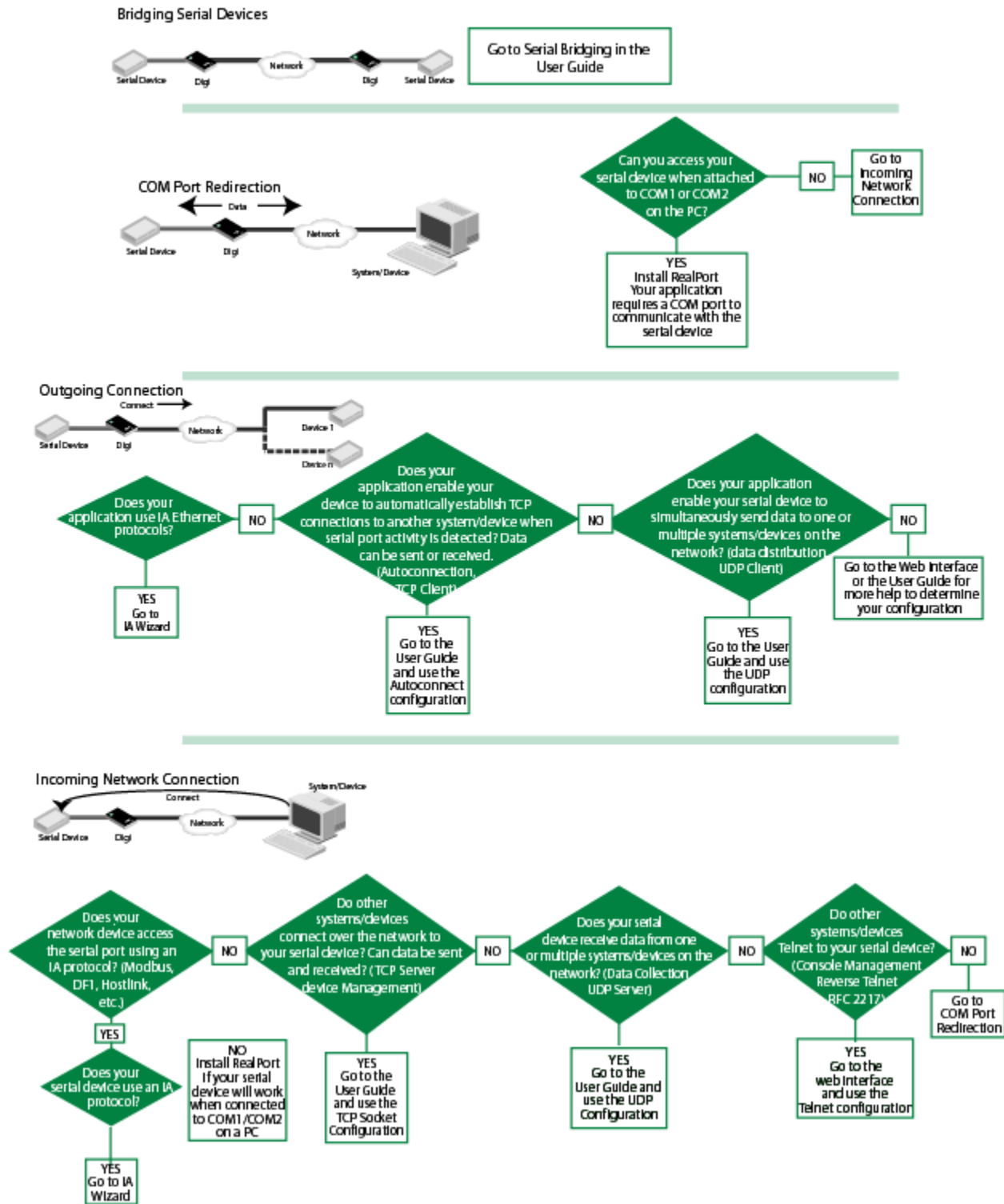

Use this chapter for the initial configuration of your Digi Wireless device. After the initial configuration, the device can be configured using the same methods as the other Digi TS family products.

Configuration Considerations

The Digi wireless devices work **ONLY** with the antennae provided. You can use the wizard available on the Software and Documentation CD to configure your wireless device. You will need an Ethernet cable and a network PC to configure the wireless Digi device. After assigning the IP address, access the device from your browser by entering the IP address in the URL address bar.



Initial Configuration Using Ethernet

1. Connect serial cable, Ethernet cable, and power supply.

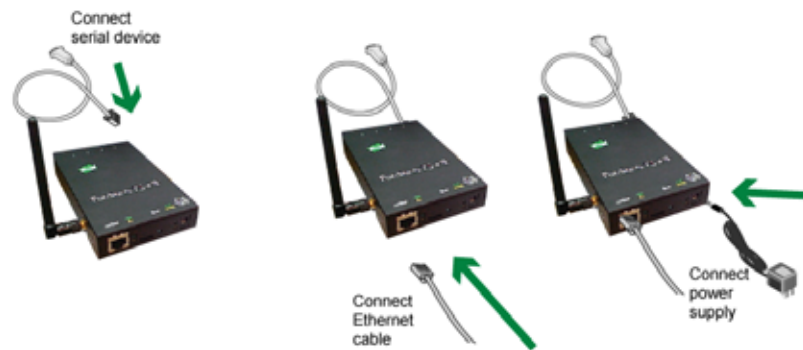

2. Insert the CD in the drive. The configuration wizard will automatically start. Follow the steps in the wizard (either for Microsoft Windows or Unix) to configure the device.

Or:

If you do not want to use the wizard, click **Cancel** and follow the remaining procedure steps to set up the IP address and configure the device through the web interface.

3. Select **Discover Digi Device (from the CD)**.
4. Select the wireless device and assign the IP address.
5. Click **Set IP**.
6. Enter the IP address, Subnet, and Gateway mask and click **OK**.
7. Select the device and click **Configure** to launch your browser.
8. Enter the username `root` and password `dbps` and click **OK**.



The home page appears.



9. Click **Network > Wireless LAN**.

10. Enter parameters, click **Apply** to save.

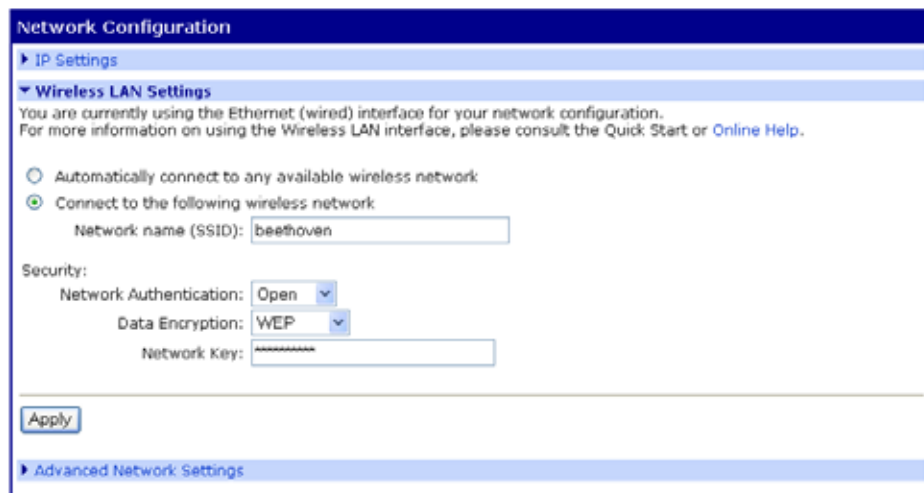

11. Click **Reboot** for changes to take effect.

WARNING!!!! Changing the Advanced Network Settings could cause you to 'lose' your device on the Network. Digi International recommends that you do NOT alter the Advanced Network Settings. If you alter these settings, you may need to reset your device with the reset button and reconfigure your device as if it were new. See "Reset Configuration to Factory Defaults" on page 103 for instructions.

Be advised these settings are correct for most environments.

12. Unplug the Ethernet cable from the Digi device, disconnect the power, and power the unit up (reboot).

Configuration is complete.

This chapter describes configuring MEI (Multiple Electrical Interface) settings through the web interface for the PortServer TS 8 MEI* and PortServer TS 16 MEI*. The internal MEI settings are switched to EIA-232 by default.

*Except for the PortServer TS 8 MEI and PortServer TS 16 MEI devices, the remaining Digi TS Family have external DIP switches for MEI settings.

About MEI Settings

PortServer TS 8/16 MEI devices are shipped with the ports switched to EIA-232 by default. The 232 drivers will generate voltages of 6V max. This voltage is well within the tolerances of EIA 422/485. The 232 drivers are current limited so they can't over-drive another EIA-422/485 output and damage their devices.

The same engineering applies if a port is set at EIA-422 and a 232 device is connected to it. The voltage generated is within the tolerance of the serial device and will not damage either device.

In either case, your serial device may or may not produce 'data chatter' - that is, text strings that have no meaning. This is an indication that the MEI settings are not in agreement and should be configured.

If there is a loss of power to the unit, the device will not lose the MEI configuration. After it boots up, it will recall and apply the last MEI settings.

Configure the MEI Switches

1. Log into the Digi PortServer TS.
2. Click **Serial Ports** > port #.
3. Select your port profile for your environment and click **Apply**.
4. Click **MEI Serial Settings**.
5. Select the Tx Control setting for your scenario.
 - Select **Tx Control** > **Always on** if this device is the only one transmitting on one wire pair, such as a single master in a master/slave configuration or if only two devices are attached.
 - Select **Tx Control** > **Auto** if multiple devices need to share the bus in a dual master scenario or if the device is acting as slave in a multi-drop environment. See "Four-Wire Multi-Drop Network Scenarios" on page 78 for more information about multi-drop scenarios.
6. Click **Apply** and the settings will take effect.
7. Repeat steps 2-6 for each port.
8. If you have not done so already, connect your serial device to the appropriate serial port.

Set the Supported Baud Rate for Multi-drop Support

The PortServer TS 8/16 MEI requires setting a baud rate range in order to perform the automatic transmitter control. This setting does not influence the performance in EIA-232 mode or for EIA-422/485 configurations where the transmitter is always on.

The range supported by default is: 50 -230400 bps

To change the supported baud rate range

1. Select **System > MEI**.
2. From the **Baud Rate** drop-down box, select the appropriate baud rate.
3. Select **Enable all serial ports** (to enable the serial port transmitter) if appropriate.
4. Click **Apply** for configuration to take effect.

Four-Wire Multi-Drop Network Scenarios

There are two scenarios of devices on a four-wire multi-drop network: the Master and the Slave. A Master has a dedicated pair of wires to talk to the Slaves. The Slaves share a return pair to the Master and need to control their transmitters so that only one device at a time uses that pair. Following are the specific procedures to set up a Master or Slave MEI setting.

MEI Configuration for a Single Master:

1. Click **Serial Ports > port # > MEI Serial Settings**.
2. Select **422/485, Tx Control > Always on**.
3. Select **Enable alternative pinout (altpin)**. This option is only enabled with 4 Wire. See the Table for Pin Outs for more information.
4. Click **Apply** for settings to take effect.

MEI Configuration for a Slave:

1. Click **Serial Ports > port # > MEI Serial Settings**.
2. Select **422/485, Tx Control > Auto**.
3. Select **Enable alternative pinout (altpin)**. This option is only enabled with 4 wire. See the "MEI Configuration for a Slave:" on page 78 for more information.
4. Click **Apply** for settings to take effect.

Note: You do not need to reboot after you click Apply for MEI settings to take effect.

Table for Pin Outs

Pin Number	EIA-232 Signal	Standard 10-Pin EIA-422/485 Signal (4/8 Wire)	Optional 8 pin EIA-422/485 Signal (Alt-4-Wire)	EIA-485 Signal (2-Wire Mode)
01	RI	TXD- (B)		
02	DSR	RxD- (B)	RxD- (B)	Data- (B)
03	RTS	RTS+ (A)	TxD+ (A)	
04	CGND	CGND	CGND	CGND
05	/TxD	TxD+ (A)		
06	/RxD	RxD+ (A)	RxD+ (A)	Data+ (A)
07	SGND	SGND	SGND	SGND
08	CTS	CTS+		
09	DTR	RTS- (B)	TxD- (B)	
10	DCD	CTS- (B)		

Embedded Modem

The PortServer TS 1 M MEI and PortServer TS 3 M MEI function as both terminal server and modem. The embedded modem can be used with PPP, dial-in, dial-out, or auto answer and conforms to the standard AT command interface.

The PortServer TS 1 M MEI and PortServer TS 3 M MEI allow:

- Remote monitoring
- Diagnostics
- Data collection
- Dial-up, wireless, or Ethernet connectivity

For a complete AT command reference, see the AT Command reference from the CD under Documentation.

The remaining ports can be configured the same as any Digi TS Family product, either through the web interface or command line.

Install the PortServer TS 1/3 M MEI

The PortServer TS 1/3 M MEI comes with a bidirectional cable for connecting the modem (port 1) to the phone line.

1. Plug the cable with the ferrite end into the modem port.
2. Plug other end into phone line.
3. Connect Ethernet.
4. Connect power supply.



Configure the PortServer TS 1/3 M MEI

1. Follow the Digi Device Setup Wizard from the CD to assign an IP address to the Digi device.
2. If the wizard scenarios need additional configuration, login to the device IP from the URL.
3. Select **Serial Ports > Change profile**
4. Select the appropriate profile (**Custom** shows all options)
5. Enter the appropriate parameters and click **Apply** to save.
6. Click **Reboot** for changes to apply.

Serial Power Feature

The Serial Power feature available for the PortServer TS P MEI Series allows the Digi device to power a serial device (power out) or use a serial device to power the Digi device (power in). The advantage of this feature is to eliminate an external power supply.

Power out is available on all ports through Ring Indicator (RI) or Data Terminal Ready (DTR). Power in is available only through RI and **only** on port one (1). The Serial Power feature is active on a specific port when that port is configured for RS 232 operation.

- The power out budget equals one (1) watt (the total amount of power available). The available power can be divided in any combination between the ports but the following rules must be observed:
 - RI = 5 volts @ up to 200 mA (max)
 - DTR = 9 volts @ up to 100 mA (max)
 - You may use DTR or RI as the source of power (power out) on any port but you may not use both DTR and RI on the same port.
- Pinout information:
 - RI is pin 1
 - DTR is pin 9
- RI signaling is lost when the pin is used for power.

Configure RI Power

RI Power In

Ring Indicator (RI) power in accepts power into the Digi device **only** on port one. Power in is available using the RI pin. The Digi device requires power in the range of 9-30 VDC @ 525mA (max). Ports 2, 3, and 4 can still supply power to a serial device through the RI or DTR pins for each port. When using power in through the RI, the external power supplies (both powered Ethernet and the barrel connector power supply) are inoperative. Altpin will not work for RI power in.

1. Open the device case and move the black jumper to the following settings:
P-6 jumper on pins 1 and 2



Note When the jumper is placed correctly for power in, the jumper will set on the pins closest to the edge of the board. The left arrow indicates the open pin and the right arrow is pointing to the jumper.

2. Close the device unit enclosure.

RI Power Out

Ring Indicator (RI) power out is available on all ports. The total power budget for this feature is one (1) watt not to exceed 5 volts @ up to 200mA on any single port. The following procedure assumes the unit will only be used for RI power out.

1. Set the port DIP switches to the following places: switch 1 and 3 are up and 2 and 4 are down (see "Serial Power Table" on page 86 for illustration).
2. Enable the RI power through the web interface.
3. Connect power supply with the barrel-connector power supply provided with the device or use powered Ethernet.

Note: If the unit will be used with RI power in (port 1 only), set the jumper to the following setting:

P-6 jumper on pins 1 and 2

and do not use an external power source. Port 1 cannot be used for both power in and power out.

Configure DTR Power

Power Out

Data Terminal Ready (DTR) power out is the factory default on the Digi device. Total power budget for this feature is one (1) watt not to exceed 9 volts @ up to 100mA to any single port.

1. Set the port DIP switches to EIA 232 (switch 1 is up, 2, 3, and 4 are down) to enable DTR power.

Open the port and set DTR high.

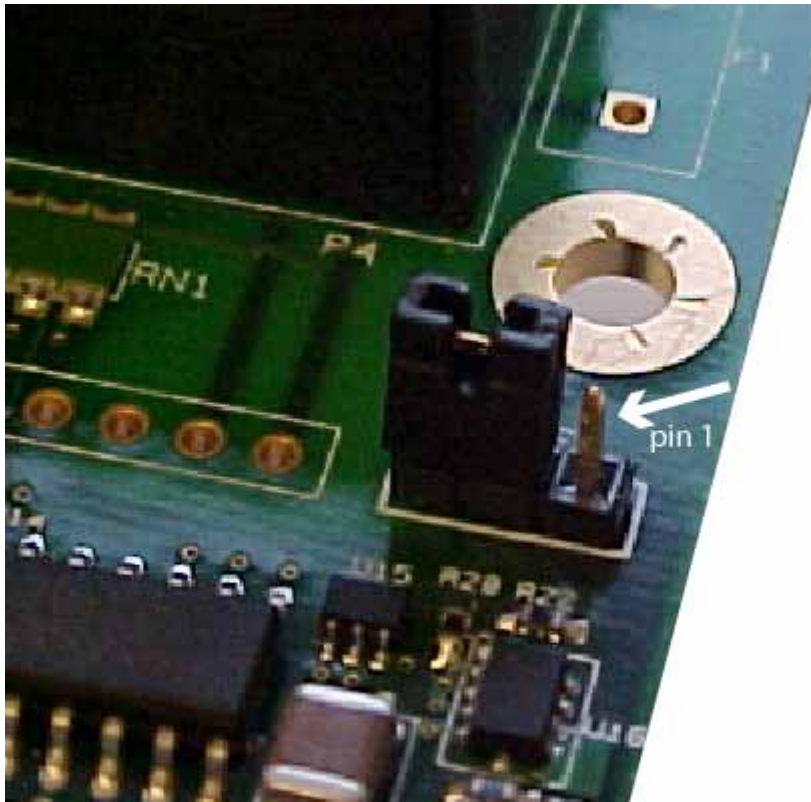

Note Here are the pins to verify the jumper position. The **default** position has the jumper on the two pins furthest from the edge. DO NOT MOVE THE JUMPER FROM THE DEFAULT UNLESS USING RI POWER IN.

If you are having trouble with your unit after using the Power over port feature, you may have tripped the circuit breaker in the unit. You can identify this by the RI or DTR signal indicators found in the System Information under Administration on the main menu in the web interface. Click the port number using serial power. (Remember serial power out is unavailable if the MEI settings are not 232.)



Under serial power will be a message if the breaker is tripped. Follow the instructions to reset.

From the command line, issue the two commands below for additional information.

- “display circuitbreaker” to display the status of the circuit breaker
- “set config circuitbreaker=reset” to reset the circuit breaker.
“set config” also displays the status of the circuitbreaker state.

Serial Power Table

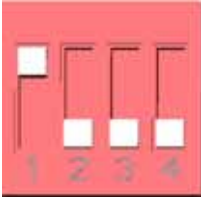
Use this table for summary information for a serial power setup.

Quick Summary Table for Setup of Serial Power	DTR Power	RI Power	
	OUT	OUT	IN
Switch Settings			
DTR setting	DTR ON	DTR OFF	DTR OFF
Ports Allowed	1, 2, 3, 4	1*, 2, 3, 4 <small>*unless port 1 is used for power in</small>	1
Jumper Pin Settings	P-6 jumper on pins 2 & 3 (Factory Default)	P-6 jumper on pins 2 & 3 (Factory Default)	P-6 jumper on pins 1 & 2
Power Budget	9v @ up to 100mA one watt	5v @ up to 200 mA one watt	9 -30 v @ up to 525mA (max)

Digi Remote Power Manager (Digi RPM) is an intelligent power distribution unit for remote power management that can be used with PortServer TS Family products. When integrated with PortServer TS products, Digi RPM allows power management and device configuration from anywhere across the corporate LAN/WAN. It provides an easy solution for the supervisory control and management of attached electrical devices.

A Digi RPM integrated with your PortServer TS product can be used to:

- Remotely power on/off/reboot devices. Power control consists of three basic functions: on, off, and reboot (power cycle).
- Measure electrical load and monitor ambient temperature.
- Configure alarms for 24/7 “real-time” monitoring and notification of out-of-spec conditions, including load and ambient temperature. A user interface is provided for configuring these alarms. Digi RPM also provides statistics on average/apparent power, RMS voltage/current, circuit breaker status and maximum current.
- Integrate with select PortServer TS terminal servers and device servers for console and power management over Ethernet.

Digi RPM is available in both eight-port 1U rack-mountable and ten-port 0U rack-mountable versions.



Configuration Scenarios Using Digi RPM

There are two typical scenarios when using Digi RPM and the power management feature with PortServer TS Family products:

- A non-serial device connected to Digi RPM
- A serial device managed by a PortServer TS device, but powered by Digi RPM

Non-Serial Device Connected to Digi RPM

The simplest scenario is a non-serial device connected to the Digi RPM; for example, an environmental sensor controller or a tape backup device. The Digi RPM's power-management settings are configured and accessed through the Web user interface for the PortServer TS device to which it is connected. This illustration shows a Digi RPM configured through a PortServer TS 16 for use in powering non-serial devices.

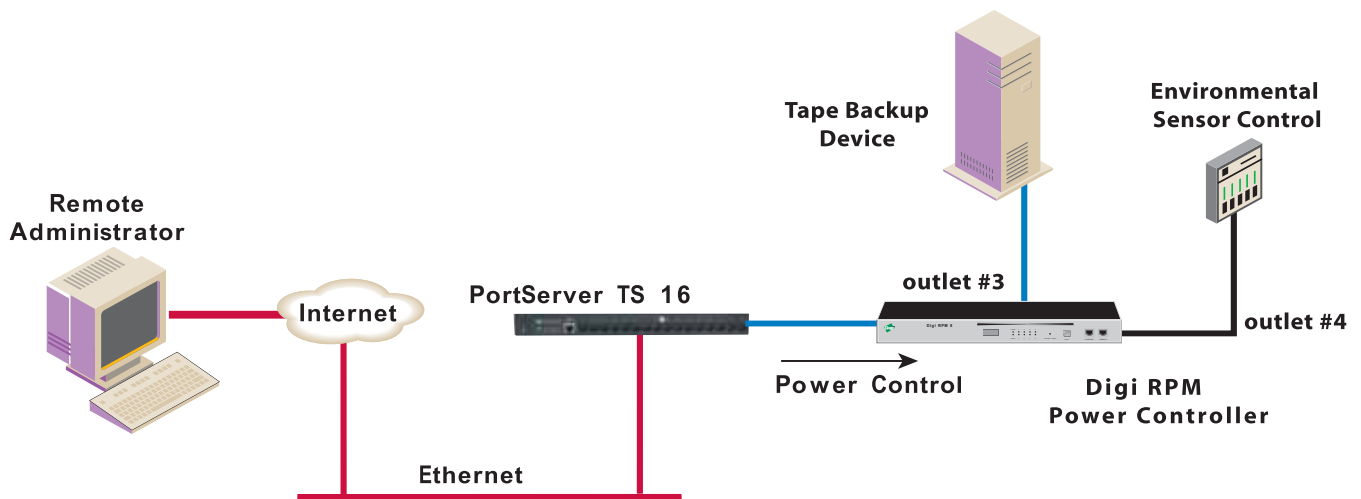

Serial Device Managed by a PortServer TS, but Powered by Digi RPM

The second configuration scenario involves a serial device, such as a router or server, that is managed through a port on a Digi PortServer TS device, but has its power supply mapped through the Power Management feature. The Digi RPM and power-management settings are configured and accessed through the Web user interface for the PortServer TS device.

After configuration of the devices in this scenario is complete, you need only reference the console management port on device server to also manage power. The Power Management feature handles the relationship of a specific outlet to a serial device as if the power supply were also connected to the same port as the serial device. In other words, you do not need to see the physical connection or remember which outlet controls a specific serial device after configuration - the PortServer TS device server does that for you. The following illustration shows a Sun server configured through a serial port connection on the PortServer TS 16.

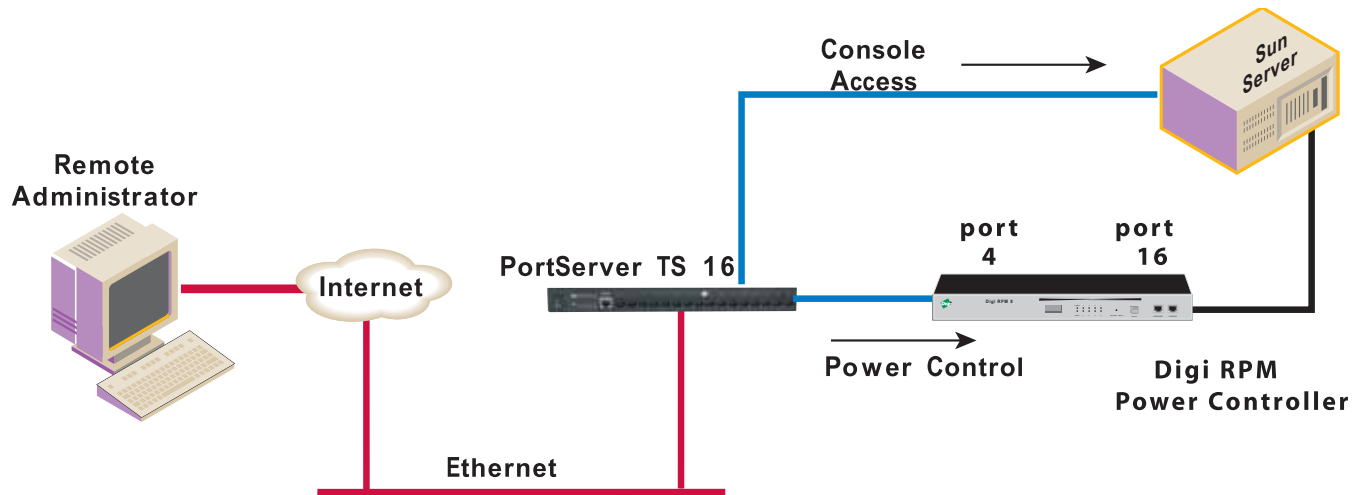

Digi RPM Configurable from Web User Interface or Command Line

Power management through the Digi RPM can be configured from either the Web user interface or command-line interface for your PortServer TS device that is connected to the Digi RPM.

From the Web user interface, which this guide emphasizes, power management is configured through the serial port settings:

Configuration > Serial Ports > port > Port Profile > Power Management

Once set up, power management equipment is monitored and controlled at:

Management > Power

From the command line, the “set powerunit” command configures power management options, and the “power” command controls and displays the status of the Digi RPM. See the *Digi One and PortServer TS Family Command Reference* for these command descriptions.

Process for Configuring and Managing Digi RPM

From the Web user interface, configuring and managing the Digi RPM involves these steps:

1. Connect the Digi RPM to the PortServer TS device and power up.
2. Configure Digi RPM settings, including optional thresholds and alarms.
3. Configure outlets on the Digi RPM, including user access permissions to the outlets.
4. Manage power devices and power controllers.
 - Manage power devices: view status of outlets and change status as needed (on, off, reboot).
 - Manage power controllers: manage individual outlets or all outlets, view current settings in the Digi RPM, including current voltage and temperature status.

Connect the Digi RPM to the PortServer TS Device and Power Up

To connect the Digi RPM to your PortServer TS device, use the PortServer TS to SunNetra (P/N 63000222-02) cable provided with the Digi RPM unit. Plug one side into the “Console” port of the Digi RPM unit and the other into any port of the PortServer TS product.

Make sure that the DIP switches of the unit are set to “Off.” Plug the Digi RPM into an appropriate power source and turn it on.

Configure Digi RPM Settings

A Power Management port profile is available for use to configure your Digi PortServer device and its serial ports for use with the Digi RPM. This port profile is used to control and manage the Digi RPM in its power-control actions (on, off, reboot).

1. Log in to the Digi PortServer TS unit (username root, password dbps).
2. Select **Configuration > Serial ports**.
3. Select the port number of the serial port you want to connect to the Digi RPM.
4. The Power Management port profile has configuration settings appropriate for a serial port connected to a Digi RPM power controller. If the Power Management port profile has not already been associated with the port through the Digi Device Setup Wizard, click **Change Profile**. Select **Power Management** from the list of port profiles and click **Apply**.

Serial Port Configuration - Port 2
Return to Serial Ports [←](#) Previous [Next](#) →

▼ Port Profile

Current Port Profile: **Power Management** [Change Profile...](#)
 The Power Management Profile allows you to control and manage a power controller to turn on and off outlets and devices.

Profile Settings

▼ Controller Settings

Automatically Detect Power Controller
 Manually Configure Power Controller

Manufacturer: ▼

Outlets: (Detected: 10 Outlets)

Thresholds:

Current Alarms (amps):

Temperature (°C):

▶ Controller Outlets

5. In the Profile Settings part of the page, select whether the power controller settings will be automatically detected or whether you will configure the settings yourself.
 - **Automatically Detect Power Controller:** Configuration settings for the Digi RPM are automatically detected after clicking **Apply**. Once the Digi RPM is detected, the settings are populated on the page. The **Manually Configure Power Controller** option is selected, allowing you to edit the settings as needed. You can correct the number of ports, if necessary, or edit the port title.
 - **Manually Configure Power Controller:** Configuration settings for the Digi RPM power controller are manually entered. Enter the following, then click **Apply**:
 - Manufacturer:** Select the manufacturer of the power controller.
 - Outlets:** Enter the number of outlets on the Digi RPM power controller.

6. Optionally, set thresholds and alarms for the Digi RPM and click **Apply**.

Digi RPM can be configured to generate an audible alarm and an SNMP trap when either of the following types of thresholds are reached on the unit:

- **Current Alarms (amps):** The current alarm threshold monitors the electric current on the Digi RPM. You can set up to four thresholds, depending on the number of current sensors on the Digi RPM. When the sensor's specified amperage level is reached, the Digi RPM will emit an audible alarm. Current alarm thresholds are configurable in the range of 0.1 to 99.9 Amps.

To generate current alarm threshold SNMP traps, you must also go to the **System > SNMP** configuration page and select **Generate Power Unit Current Threshold Traps** option, and specify a destination IP address for the SNMP trap.

- **Temperature (°C):** This alarm threshold monitors the temperature on the Digi RPM. You can set up to four thresholds, depending on the number of temperature sensors on the Digi RPM. When the sensor's specified temperature is exceeded, the Digi RPM will emit an audible alarm.

Temperature alarm thresholds are configurable in the range of 0.1 to 99.9 °C

To generate temperature threshold traps, you must also go to the **System > SNMP** configuration page, select **Generate Power Unit Temperature Threshold Traps** option, and specify a destination IP address for the SNMP trap.

Configure Outlets

Next, configure the PortServer TS to link serial ports to outlets on the Digi RPM. From each outlet on the Digi RPM, you can set a name for it, tie its use to a serial port, and control user access to the outlet for power management.

1. On the Port Profile page, click **Controller Outlets**. A list of other Digi RPM power controller's outlets is displayed, along with a summary of each outlet's current configuration. The number of outlets displayed is the same as the value entered for Outlets on the Controller Settings page.

Outlet	Device Name	Serial Port	Status	Action
1	outlet02_01	None	Off	Unplug Device...
2	outlet02_02	None	On	Unplug Device...
3	outlet02_03	None	Off	Unplug Device...
4	outlet02_04	None	On	Unplug Device...
5	outlet02_05	None	On	Unplug Device...
6	outlet02_06	None	On	Unplug Device...
7	outlet02_07	None	On	Unplug Device...
8	outlet02_08	None	On	Unplug Device...
9	outlet02_09	None	On	Unplug Device...
10	outlet02_10	None	On	Unplug Device...

2. You can either edit outlet settings or clear them.
 - To edit the settings of a power outlet, click on that outlet's link under the **Outlet** or **Device Name** heading.
 - To clear the settings of a power outlet, click on **Unplug Device...** under the **Action** heading, and confirm that you want to clear the settings.

3. The Power Outlet Configuration page is displayed.

Power Outlet Configuration - Outlet 1 Return to Power Outlets Previous Next

Device Name:

Serial Port:

Power Management Access

Username	Action
No users currently configured	
<input type="text" value="test"/>	<input type="button" value="Add..."/>

Apply these users to all outlets with the same device name
 Apply these users to all outlets with the same serial port

- In the **Device Name** field, enter a name for the device plugged into this power outlet. If you give the same device name to multiple devices, such as “router,” they can be managed as a single entity. For example, multiple servers that have been assigned the same Device Name can be shut down or rebooted.
- If the powered device is a serial device, in the **Serial Port** field, specify the serial port to which the powered device is connected.
- In the **Power Management Access** section, configure user access permissions to the outlet.

Users can be assigned permission to manage the outlet. A user with access permissions to the outlet will have the option to power a connected device on or off or reboot the device.

Individual users must already be configured before they can be assigned to manage power outlets. To add users, go to Configuration > Users.

Users that currently have permission to control the outlet are listed in the **Username/Action** table.

To allow a user access permissions to the outlet: In the bottom row, select a **Username** and click **Add**.

To restrict a user from accessing the outlet: Click **Remove**.

Apply these users to all outlets with the same device name:

Apply these users to all outlets with the same serial port:

These options allow you to easily assign the same users to manage each outlet with the same device name or serial port.

4. Click **Apply** and repeat steps 2-3 for each outlet you want to configure.

Manage Power Devices and Power Controllers

After power devices and controllers are configured, you can manage them. From the Web user interface, go to **Management > Power**. From the command line interface, issue the “power” command.

In the Web user interface, there are two power-management actions: **Manage Power Devices** and **Manage Power Controllers**.

Manage Power Devices

The Manage Power Devices page shows the status of outlets and allows you to change the power-cycle action of each outlet (on, off, reboot).

Power Management		
▼ Manage Power Devices		
Device Name	Status	Action
outlet02_01	Off	Power...
outlet02_02	On	Power...
outlet02_03	Off	Power...
outlet02_04	On	Power...
outlet02_05	On	Power...
outlet02_06	On	Power...
outlet02_07	On	Power...
outlet02_08	On	Power...
outlet02_09	On	Power...
outlet02_10	On	Power...
▶ Manage Power Controllers		

To change the power-cycle action, click **Power** and choose the available action. This change affects the power-cycle action for all outlets assigned the same device name.

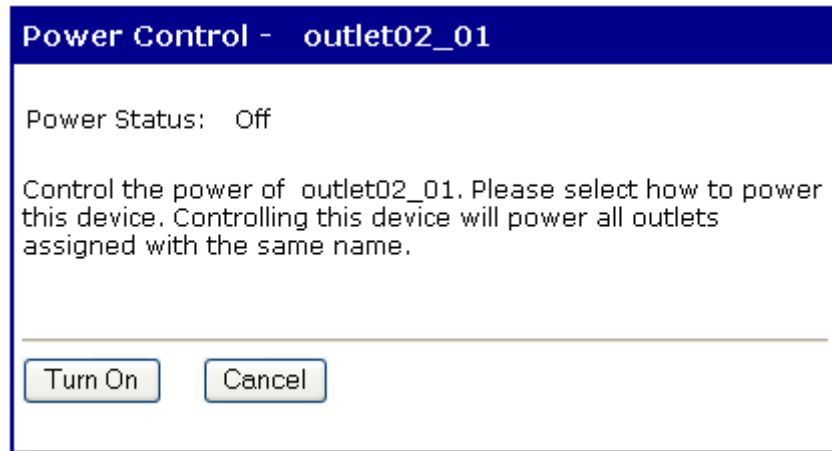

Manage Power Controllers

The Manage Power Controllers page allows you to get a quick update of the status of Digi RPM power controllers configured for use with your PortServer TS device, and to power all outlets for each Digi RPM power controller.

Controller	Outlets	Status	Action
Digi RPM on Port 2	10	Connected	Power all Outlets...
All Power Controllers	N/A	N/A	Power all Outlets...

Display Power Controller Status

In the list of power controllers, the Status field shows the brief status of the Digi RPM power controller, such as whether it is connected or disconnected.

For more detailed status of the power controller, click the power controller's name, for example, **Digi RPM on Port 2**. The Controller Status page displays the current state of the Digi RPM power controller, including circuit breaker condition, temperature threshold, current temperature, RMS voltage, alarm threshold, RMS current, and the maximum current detected.

Clicking the **Reset** button resets the Max Current Detected value to 0.0 amps.

The **Refresh** button refreshes the status values.

Power Management - Digi RPM on Port 2

[Return to Power Management](#)
← Previous
Next →

▼ Controller Status

Model: RPM10
 Firmware: v1.0.0

Sensors:

Name	Sensor 1	Action
Circuit Breaker	Good	
Temperature Threshold	37.7° C	
Temperature	27.0° C	
Voltage	120.0 volts	
Alarm Threshold	99.0 amps	
RMS Current	0.0 amps	
Max Current Detected	0.0 amps	<input type="button" value="Reset"/>

Manage Power Devices and Power Controllers

Manage All Outlets at Once

From the Manage Power Controllers page, you can power all outlets for the Digi RPM by clicking **Power all Outlets**.

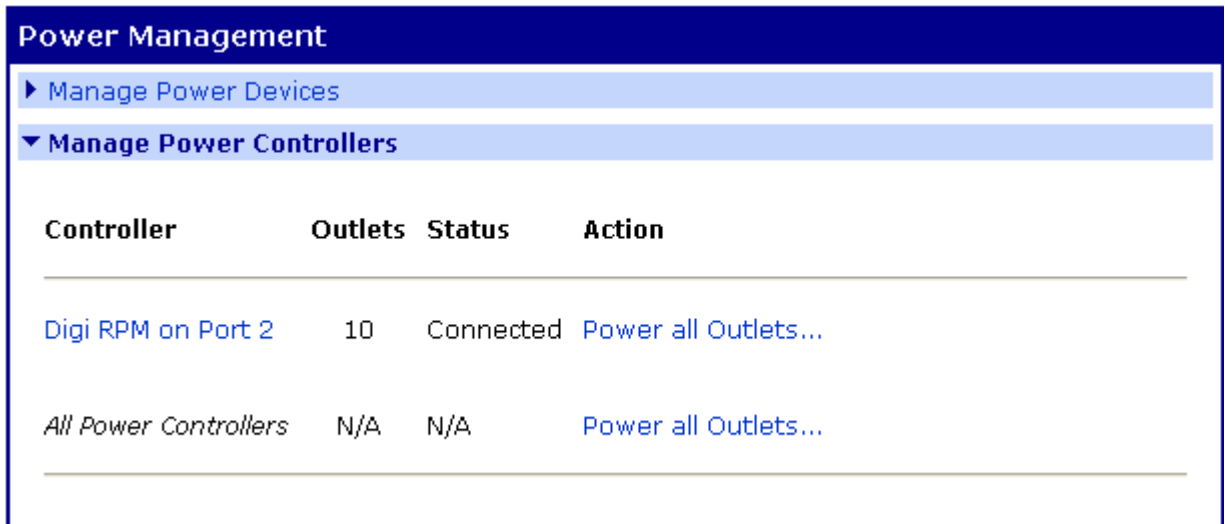

The screenshot shows a web interface titled "Power Management". It has two main menu items: "Manage Power Devices" and "Manage Power Controllers". The "Manage Power Controllers" section is expanded, showing a table with the following data:

Controller	Outlets	Status	Action
Digi RPM on Port 2	10	Connected	Power all Outlets...
All Power Controllers	N/A	N/A	Power all Outlets...

Depending on what you want the outlets to do, click Turn On, Turn Off, Reboot, or cancel the operation.

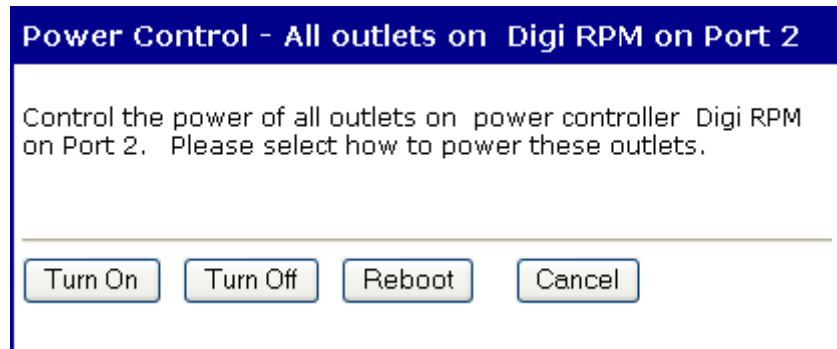

The screenshot shows a dialog box titled "Power Control - All outlets on Digi RPM on Port 2". The text inside the dialog reads: "Control the power of all outlets on power controller Digi RPM on Port 2. Please select how to power these outlets." Below the text are four buttons: "Turn On", "Turn Off", "Reboot", and "Cancel".

This chapter describes configuring Simple Network Management Protocol (SNMP), the network management protocol that governs the exchange between nodes and stations.

About SNMP and the Digi Device Agent

This section introduces SNMP and network management in TCP/IP networks and it describes the device server agent. It discusses the following:

- Network management components
- SNMP agent
- SNMP traps
- MIB (management information base) support of the Digi device agent
- Support traps of the Digi device agent

Network Management Components

The TCP/IP network management architecture contains the following components:

- Managed nodes such as host systems, routers, terminal and communications servers (such as device server) and other network devices.
- One or more network managers (also called network management stations), which are the points from which the network is managed
- Agents that reside on managed nodes and retrieve management information and communicate this information to network managers.
- The network management protocol, SNMP, which governs the exchange of information between the nodes and stations.
- Management information, which is the database of information about managed objects. This database is called the *management information base* (MIB).

SNMP Management Agent

Each managed node contains at least one agent—a component that responds to requests from the network manager—that retrieves network management information from its node and notifies the manager when significant events occur.

SNMP Traps

An ‘eventing’ mechanism defined by SNMP is called a trap, which is a report or “alarm” from a managed node to an SNMP manager that a significant event has occurred.

MIB Support

The SNMP management agent supports the following MIBs:

- Read-write for MIB II (RFC 1213), which is an Internet-standard MIB, consisting of managed objects from the systems, interfaces, IP, ICMP, TCP, UDP, transmission, and SNMP group.
- Read-write for the character-stream devices using SMIv2 MIB (RFC 1658).
- Read-write for the RS-232-like hardware devices MIB (RFC 1659).
- Read-write for the device server IP Network Control Protocol of the Point-to-Point Protocol MIB (RFC 1473).

Message Support

The SNMP agent supports the Set, Get, GetNext, and Trap messages as defined in RFC 1157. These messages are used as follows:

- Set, which means set the value of a specific object from one of the supported MIBs.
- Get, which means retrieve the value of a specific object from one of the supported MIBs.
- GetNext, which means retrieve the value of the next object in the MIB.
- Trap, which means send traps to the manager when a particular type of significant event occurs.

Supported Traps

The agent can send traps when any of the following occur:

- Cold starts (device server initializes)
- Authentication failures
- Login attempts

Configuration Procedure: Web Interface

1. In the main menu, under **System**, click **SNMP**.
2. Fill in the configuration fields and click **Apply** to save settings.
3. Click **Reboot** for changes to take effect.

This chapter describes configuration management activities, including firmware upgrades, backup/restore operations for device configuration files, and restoring the device configuration to defaults.

Upgrade Firmware

Firmware upgrades can be performed from the web interface, using TFTP.

TFTP Upgrade Procedure

If your hardware is connected correctly, make sure you are running the latest firmware version available. Check the Digi Support site for the latest firmware and/or POST updates for your device:

1. Download a copy of the firmware file.
2. Access the Digi device's web interface by entering the Digi device's IP address in a browser's URL window and log on (User Name `root`, Password `dbps`).
3. From the main menu, choose **Administration > Update Firmware**.
4. Browse to the location on your system where the firmware has been saved, select the correct file, and click **Update**.
5. Reboot the device when prompted.
6. **Important:** Do not leave your browser until you are prompted to reboot.
7. Access the Digi device's web interface and verify on the Information Page that the Firmware version has been successfully updated.

Backup/Restore Device Configuration Settings

You can backup a device's current configuration settings and use them to restore the device's configuration settings or configure another device. The device configuration settings can be saved to a file on your PC or to TFTP server.

A typical use for this backup/restore operation is when you have several device servers with similar configurations and want to keep a master configuration on a remote host, from which you can easily create variations for downloading to individual device servers.

If you are familiar with the command-line interface, you can also use a backup file to configure the Digi device remotely by entering commands in a text file and then copying the file to the Digi device.

You can copy settings to another device by restoring settings from this backup file to the other device. If you are using static IP addresses you will want to edit the backup file with a text editor to modify or remove the 'set config' command containing the "ip" and "submask" fields.

Backup Device Configuration Settings to a File

1. Access the web interface by entering the Digi device's IP address in a browser's URL window.
2. Log on to the Digi device as `root`. The default password is `dbps`.
3. From the main menu, choose **Administration > Backup/Restore**.
4. Click **Backup**. Enter or confirm the filename and location for the backup file location and filename for saving the configuration, and click **Save**.

Restore Device Configuration Settings from a File

1. Access the web interface by entering the Digi device's IP address in a browser's URL window.
2. Log on to the Digi device as `root`. The default password is `dbps`.
3. From the main menu, choose **Administration > Backup/Restore**.
4. In the Restore From File field, enter the name of the backup file, using the **Browse** button as needed to locate the file.
5. Click **Restore**.

Backup/Restore to and from a TFTP Server

1. Ensure that TFTP is running on the remote host.
2. Access the web interface by entering the Digi devices's IP address in a browser's URL window.
3. Log on to the Digi device as `root`. The default password is `dbps`.
4. From the main menu, choose **Backup/Restore > TFTP Server**.
5. Enter the name of the file and the IP address of the TFTP server and click **Backup** (to save the file) or **Restore** (to apply the file).

Reset Configuration to Factory Defaults

Caution: Resetting your Digi device configuration to factory defaults causes it lose all configuration changes, including IP address settings. If you have a complex configuration, contact Digi about saving your configuration before resetting the configuration to factory defaults. See Chapter 13, "Reference and Certifications" for information.

1. Locate the reset button on your Digi device. The reset button is in one of four common locations, shown in the figures below.
2. Use a pen, the point of a paper clip, or some other device to press the recessed button on the front panel. Although the object used to access the reset button must be pointed, be sure it is not sharp or it may damage the reset button.
3. While holding down the button, power on the Digi device.
4. When the 1-5-1 LED pattern is displayed, release the button.
5. It may take approximately two minutes for the device to boot up.

Reset Button Locations

Digi One SP and Digi One SP/IA Products

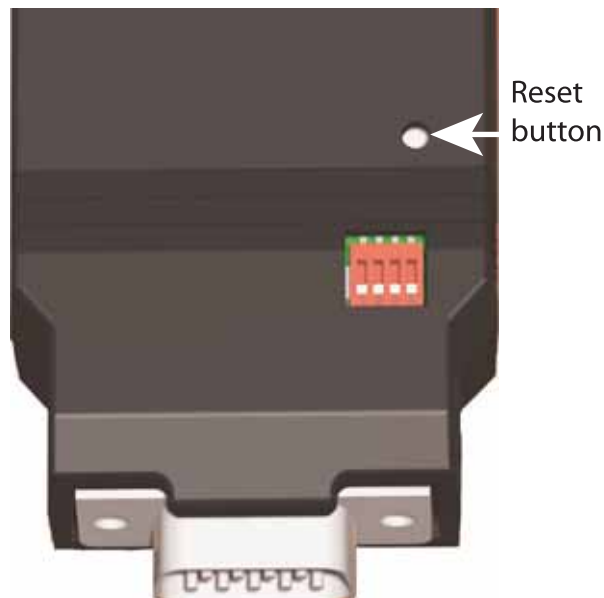

Digi One IA and Digi One IAP Products

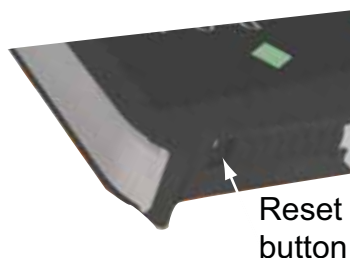

Reset Configuration to Factory Defaults

PortServer TS 8/16 Products



Reset ↑
button

PortServer TS 1/2/4 Products



Reset
button

This chapter discusses latency and a recommended process for defining and addressing latency issues in your network and application.

What is Latency?

Latency is the amount of time it takes a packet to travel from source to destination. Together, latency and bandwidth define the speed and capacity of a network.

Several factors influence latency, including the traffic pattern and traffic generated by an application, the physical wiring for the network, the use of various TCP/IP timers, and the amount of additional traffic on the network besides that generated by the application.

Recommended Process for Latency Tuning

Following is a process recommended to achieve deterministic Ethernet networking behavior. It uses Digi commercial off-the-shelf (COTS) firmware and hardware, and not any specialized products specifically designed to reduce latency. By following this process, you should be able to define and address latency issues at multiple levels in your network and application.

In summary, the process involves five steps:

1. Determine the characteristics of your application, in terms of traffic pattern and amount of traffic generated.
2. Determine the latency budget and the type of latency in which you are interested.
3. If applicable, depending on the results produced in steps 1 and 2, optimize the physical layer.
4. If applicable, depending on the results produced in steps 1, 2, and 3, optimize the network and transport layer.
5. If applicable, depending on the results produced in steps 1, 2, 3, and 4, optimize the application layer.

Best-case scenario

The best-case scenario for achieving deterministic Ethernet networking behavior with DIGI COTS firmware and hardware is a unidirectional master-slave application running over an isolated Ethernet network that is built around Ethernet switches instead of Ethernet hubs. In other words, the best-case scenario is a network that eliminates unnecessary traffic and minimizes Ethernet collisions.

Step 1: Determine the characteristics of your application

The first step in addressing latency is to consider the characteristics of your application in terms of traffic pattern and amount of traffic generated.

- What is the main purpose of the application, and the primary activities?
- Traffic pattern: Is it peer-to-peer or master-slave application?
- Amount of traffic generated (x bytes every y minutes): How much data is being transmitted from and received by the application, and over what amount of time? For example, 200 bytes of data sent over 500 milliseconds.

Step 2: Determine latency budget and type of latency

Identifying the latency budget for your application involves defining what latency means for your network and the application running on it. This latency budget influences how much optimization you may need to perform at the physical, data link/network, and application layers.

- Define how much latency is acceptable.
- Is the latency one-way or round-trip?

Step 3: Optimize the physical layer

Depending on the results produced in steps 1 and 2, optimize the physical layer; that is, address the physical-layer characteristics that can affect latency.

Optimizing the physical layer, may include, but is not limited to, these recommendations:

- Use Ethernet switches instead of Ethernet hubs to minimize unnecessary traffic and minimize collisions.
- Use industrial-strength cabling and make sure the wiring is sound. Bad wiring can result in increased collisions.
- Eliminate impedance mismatches.
- Avoid running communications cabling on the same tracks with power cabling or other cabling exhibiting fast voltage swings
- Use a smaller less noise-induced error-prone Ethernet, or data rate. Lower Ethernet speeds have higher voltages, at which background noise is less relevant and has less of an impact on latency. Voltages associated with 10, 100, and 1000 mbps Ethernet speeds are:
 - 10 mbps: 2.3V (CAT5)
 - 100 mbps: 0.8V (CAT5)
 - 1000 mbps: 0.5V (CAT5E/CAT6)
- Ground to earth all your networking equipment, including the Digi device.
- Use only networking equipment that is certified or known to operate well within the required ranges for vibrations, shock, operating temperature, relative humidity, etc.

Step 4: Optimize the network and transport layers

Depending on the results produced in steps 1, 2, and 3, optimize the network and transport layers. Optimizing the network and transport layers, may include, but is not limited to, these recommendations:

- Isolate any unnecessary TCP/IP traffic from the network.
- Choose smaller packets to reduce transit times through intermediate networking devices, as most of these devices are store-and-forward.
- Increase the TCP/IP responsiveness to incoming/outgoing traffic by choosing appropriate values for various TCP/IP timers, such as the retransmission timer, the gratuitous ARP timer, and delayed acknowledgment timer.
- Avoid the use of time-consuming encryption facilities.

Command options for optimizing network and transport layers

A major contributor to latency for the network and transport layers is unnecessary retransmissions of data. The command-line interface has several command options to help you reduce these unnecessary retransmissions. Most of these options are available through the command-line interface only, and not the Web user interface.

For complete descriptions of these commands and options, see the *Digi One and PortServer TS Family Command Reference*.

There are several considerations for using these latency-related command options:

- Changing the options from their defaults may violate RFCs.
- Decrementing the values for these options increases the amount of network activity, for example, there will be increased retransmissions.
- For a peer-to-peer application, you need to consider both sides of the connection and how options are set. For example, if the setting for the “rto_min” option for the Digi device is set to a value that is less than the setting for the “delayed_ack” option for the other side of the connection, then there will be a forced retransmission of every packet of data. For a master-slave application, this consideration does not apply.

Recommended Process for Latency Tuning

Command	Option	Description
set tcpip	garp=30-3600	<p>The frequency of Gratuitous ARP (GARP) announcements. A Gratuitous ARP is a broadcast announcement to the network of a device's MAC address and the IP address being used for it. This allows the network to update its ARP cache tables without performing an ARP request on the network.</p> <p>Gratuitous ARP announcements can affect latency in a limited way, because some systems stall or dispose of data that is transmitted during an ARP cache refresh. If this happens, setting the Gratuitous ARP frequency to be more often than the problem system's time-to-live variable can cause it to refresh the cache without needing to perform a request.</p>
	rto_min=30-1000	<p>The TCP minimum retransmission time out (RTO), in milliseconds.</p> <p>TCP uses progressively larger retransmit values, starting at a minimum value that is calculated from a sliding window of ACK response round-trip times that is bounded at the bottom by "rto_min." So, essentially, "rto_min" is not necessarily the timeout that will be used as the starting retransmit timeout, but it is the smallest such value that could be used.</p> <p>This affects latency, because lowering "rto_min" ensures that retransmits take place in less time if they occur. By occurring sooner, the network is able to recover the lost data in less time at the expense of possibly retransmitting data that is still in-flight or successfully received by the other side, but unacknowledged due to a "delayed ACK" mechanism or something similar.</p>
set config	<p>optimize={latency throughput}</p> <p>This option is also available in the Web user interface at: Configuration > System > Optimization setting.</p>	<p>Configures how the Digi device handles network latency.</p> <p>If your Digi device handles delay-sensitive data, choose "optimize=latency." If overall network throughput is more important than latency, choose "optimize=throughput." For the Digi One IAP, the default is "latency." For all other models, the default is "throughput."</p>

Step 5: Optimize the application layer

Optimizing the application layer may include, but is not limited to, these recommendations:

- Avoid having more than one application/network node generating time-sensitive traffic in the network. Have one traffic generator in a master-slave setup on the network.
- Avoid running other (management) applications, such as email, image or mp3 downloading, etc., while time-sensitive traffic is running.
- Check whether the application itself has timers that cause retransmissions of data.
- Use firewalls.

Interpreting the LEDs

LEDs for PortServer TS 1/2/4-Port and Digi One Family Products

LED		Color	State	Indicates
Power LEDs	Power (labeled PWR)	Green	On	Power detected
			Steady blinking	Waiting for an IP address or seeking an IP address from a DHCP server
			Blinking 1-1-1	Starting the EOS
			Blinking 1-3-1	Starting the TFTP process
			Blinking 1-5-1	Configuration returned to factory defaults
			Blinking 9-1-1	Contact Tech Support for help. 1-952-912-3444 or outside the U.S. +1 (952) 912-3444
			Off	No power detected
	Radio Signal Strength (labeled Signal for Wireless labeled CD/ACT for Embedded Modem)	Yellow	Varying brightness	Signal strength relates to brightness or dimness of the light
Modem- Carrier detected			Modem is online	
Ethernet LEDs	Link (labeled Link)	Green	On	Physical network detected
			Off	No physical network detected
	ACT (labeled ACT)	Yellow	On	Bad initialization
			Off	Ready
			Blinking	Network activity

Note: For all PortServer TS and PortServer TS MEI product families, if LED activity is solid, it means the boot completed successfully.

Interpreting the LEDs

LEDs for PortServer TS 8/16 Products

LED	Color	State	Indicates
Power	Green	On	Power detected.
		Blinking	Indicates that there is data stored in the error log for the PortServer TS device. To view and clear the error log, go to the command-line interface for the PortServer TS device. To view the error log, enter display error . To clear the error log, enter display error clear .
Link	Green	On	Physical Network detected.
		Off	No physical network detected.
10/100	Green	On	100Mbit Ethernet detected.
		Off	10Mbit Ethernet detected.
ACT	Green	On	Bad initialization.
		Off	Ready.
		Blinking	Network activity.
COL	Amber	On	Ethernet collision detected.
		Off	No Ethernet collision detected.

Device EIA 232/422/485 Switch Settings

Note: MEI Switch settings apply only to devices with external MEI switches.

Function	Switch Settings			
	1	2	3	4
EIA-232	Up	Down	Down	Down
EIA-422/485 Full-duplex	Down	Down	Down	If up, termination. If down, no termination
EIA-485 half-duplex	Down	Down	Up	

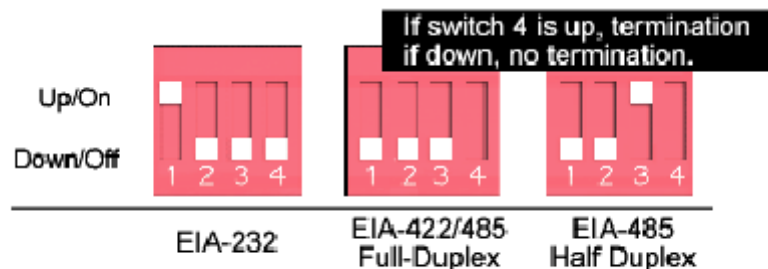

RJ-45 Pinouts

Pin Number	EIA-232 Signal	Standard 10-Pin EIA-422 Signal (4/8 Wire)	Optional 8 pin EIA-422 Signal (Alt-4Wire) PortServer TS 8/16 MEI only	EIA-485 Signal (2-Wire Mode)
01	RI	TXD- (B)		
02	DSR	RxD- (B)	RxD- (B)	Data- (B)
03	RTS	RTS+ (A)	TxD+ (A)	
04	CGND	CGND	CGND	CGND
05	/TxD	TxD+ (A)		
06	/RxD	RxD+ (A)	RxD+ (A)	Data+ (A)
07	SGND	SGND	SGND	SGND
08	CTS	CTS+		
09	DTR	RTS- (B)	TxD- (B)	
10	DCD	CTS- (B)		

Safety Statements

PortServer TS 8/16

WARNING: To prevent electric shock, do not remove the cover of this module while unit is powered up. There are no user-serviceable parts inside. Refer servicing to qualified personnel.

WARNING: Product sold outside the USA or Canada will need to provide appropriate foreign power cord set.

Power Cord Requirements:

- Listed, detachable, maximum 4.5m (14.7 ft) long.
- Rated minimum 125v or 250v, 10A Type SJT or Type SUT flexible cord
- Terminated with IEC320 type appliance plug

Rack Mounting Installation (PortServer TS 16 Rack and DC Rack)

- Distribute weight evenly in the rack to avoid overloading.
- Check equipment nameplate ratings before connecting to the supply circuit to avoid overloads which may damage over-current protection devices and supply wiring.
- Maintain reliable earthing for rack-mounting equipment, especially for supply connections.
- Install equipment in Restricted Access Areas only (dedicated equipment rooms/closets) in accordance with Articles 110-16, 110-17, and 110-18 of the National Electrical Code, ANSI/NFPA 70.
- Connect equipment to a DC supply source (reliably earthed) that is electrically isolated from the AC source.
- Directly connect the equipment chassis to the DC supply system-grounding electrode conductor or a bonding jumper from a grounding terminal bar (or bus) that is connected to the DC supply system grounding electrode conductor.
- Contain equipment that has a connection between the grounded conductor of the same DC supply circuit, the grounding conductor, and also the point of grounding of the DC system in the same immediate area. Do not ground the equipment elsewhere.
- Locate the DC supply source within the same premises as the equipment.
- Route away and secure all DC input wiring from sharp edges to prevent chaffing as well as provide strain relief.

Provide a readily accessible disconnect device and protective device a fixed wiring for a DC power supply suitable for the specified rated voltage and current. Disconnect and protective devices to be rated 2A Amps maximum.



PortServer TS 1/3 M MEI

To avoid contact with electrical current:

- Never install electrical wiring during an electrical storm.
- Never install telephone jacks in wet locations unless that jack is specifically designed for wet locations.
- Use caution when installing or modifying telephone lines.
- Use a screwdriver and other tools with insulated handles.
- You and those around you should wear safety glasses or goggles.
- Do not place telephone wiring or connections in any conduit, outlet or junction box containing electrical wiring.

WARNING	Do not work on your telephone wiring if you wear a pacemaker. Telephone lines carry electrical current.
----------------	---

- Installation of inside wire may bring you close to electrical wire, conduit, terminals and other electrical facilities. Extreme caution must be used to avoid electrical shock from such facilities. You must avoid contact with all such facilities.
- Telephone wiring must be at least 6 feet from bare power wiring or lightning rods and associated wires, and at least 6 inches from other wire (antenna wires, doorbell wires, wires from transformers to neon signs), steam or hot water pipes, and heating ducts.
- Before working with existing inside wiring, check all electrical outlets for a square telephone dial light transformer and unplug it from the electrical outlet. Failure to unplug all telephone transformers can cause electrical shock.
- Do not place a jack where it would allow a person to use the telephone while in a bathtub, shower, swimming pool, or similar hazardous location.
- Protectors and grounding wire placed by the service provider must not be connected to, removed, or modified by the customer.

	Do not touch uninsulated telephone wiring if lightning is likely!
	External Wiring Any <i>external</i> communications wiring you may install needs to be constructed to all relevant electrical codes. In the United States this is the National Electrical Code Article 800. Contact a licensed electrician for details.

Safety Statements

Class I Division 2, Groups A,B,C,D Hazardous Location

Applicable to these products:

- Digi One IA
- Digi One IAP
- Digi One IAP Haz
- PortServer TS 1 Haz MEI
- PortServer TS 2 Haz MEI
- PortServer TS 4 Haz ME

This equipment is suitable for use in Class I, Division 2, Groups A, B, C and D or Non-hazardous locations only.

Warning: Explosion Hazard – Substitution of components may impair suitability for Class I, Division 2.

Warning: Explosion Hazard – Do not disconnect equipment unless power has been switched off or the area is known to be non-hazardous.

Wiring Terminals for Digi One IA

Wiring terminals shall be plainly marked in the instruction manual delivered with base product, or the device shall be provided with a wiring diagram to indicate the proper connections. Wiring terminals shall also be marked with the tightening torque in 5 lb. in. and “Use Copper Conductors Only.”

Specifications

Power Requirements

Product	Typical Power Consumption DC Current @ 120 Vac (mA)	Max Power Consumption (watts)	Recommended Power Supply Input Rating (watts)
<ul style="list-style-type: none"> PortServer TS PortServer TS MEI PortServer TS M MEI PortServer TS W MEI PortServer TS P MEI 	4W (330mA @ 12 Vdc)	12W (1A @ 12Vdc)	42W (120V * 35A) External power supply provided with product purchase
<ul style="list-style-type: none"> PortServer TS 8 	6W (500mA @ 12Vdc)	12W (1A @ 12Vdc)	42W (120V * 35A) External power supply provided with product purchase
<ul style="list-style-type: none"> PortServer TS 8 DC 	6W (125mA @ 48Vdc)	12W (.25A @ 48Vdc)	20W (.4A @ 48Vdc) External power supply provided with product purchase
<ul style="list-style-type: none"> PortServer TS 16 DC 	10W (200mA @ 48Vdc)	20W (.4A @ 48Vdc)	25W (.45A @ 48Vdc)
<ul style="list-style-type: none"> PortServer TS 8 MEI PortServer TS 16 PortServer TS 16 MEI 	10W (85mA @ 120Vdc)	20W (.17 A @12Vdc)	96W (120V * 8A)
<ul style="list-style-type: none"> PortServer TS 16 Rack DC 	12W 2 (250mA @ 48Vdc)	29W (600mA @ 48Vdc)	34W (700mA @ 48Vdc)
<ul style="list-style-type: none"> Digi One SP Digi One IA Digi One IAP Digi One IAP Haz 	Device is intended to be powered by a listed LPS or Class II power supply rated. 9-30 VDC (barrel connector), 0.37 A minimum or its equivalent.		
<ul style="list-style-type: none"> Digi One IAP PortServer TS P MEI 		<p>Power over Ethernet IEEE 802.3af:</p> <p>IEEE 802.3af defines two types of power source equipment: end-span and mid-span.</p> <ul style="list-style-type: none"> End-span refers to an Ethernet switch with embedded Power over Ethernet technology. These new switches deliver data and power over the same wiring pairs - transmission pairs 1/2 and 3/6. <p>Mid-span devices resemble patch panels. They are placed between legacy switches and the powered devices. Each of the mid-span ports has an RJ-45 data input and data/power RJ-45 output connector. Mid-span devices tap the unused wire pairs 4/5 and 7/8 to carry power, while data runs on the other wire pairs.</p> <p>Digi One IAP and PortServer TS P MEI and are mid-span and end-span.</p> <p>Typical: 4 watts Max: 6 watts</p>	

Specifications

Product	Typical Power Consumption DC Current @ 120 Vac (mA)	Max Power Consumption (watts)	Recommended Power Supply Input Rating (watts)
<ul style="list-style-type: none"> • PortServer TS 1 H MEI • PortServer TS 2 H MEI • PortServer TS 4 H MEI • PortServer TS 1 H^{CC} MEI • PortServer TS 2 H^{CC} MEI • PortServer TS 4 H^{CC} MEI • PortServer TS 1 Haz MEI • PortServer TS 2 Haz MEI • PortServer TS 4 Haz MEI (H - High Temperature Models)	Device is intended to be powered by a listed /CN ITE power supply rated 12 VDC (barrel connector), 1.0 A minimum.		

Physical Requirements

Attributes	PortServer TS PortServer TS MEI PortServer TS W MEI PortServer TS M MEI PortServer TS P MEI	Digi One IA Digi One IAP Digi One IAP Haz	Digi One SP Digi One SP IA	PortServer TS 8	PortServer TS 16	PortServer TS 8/16 MEI PortServer TS 16 Rack	PortServer TS 16 Rack DC	PortServer TS H MEI PortServer TS H ^{CC} MEI PortServer TS Haz MEI
Length	13.31cm 5.24 in	12 cm 4.7 in	9.4 cm 3.7 in.	21.08 cm 8.3 in	34.04 cm 13.4 in	42.7 cm 16.8 in		13.31 cm 5.24 in
Width	8.46 cm 3.3 in	2.3 cm 0.9 in	4.3 cm 1.72 in.	9.4 cm 3.7 in	16.76 cm 6.6 in	16.76 cm 6.6 in	18.44 cm 7.26	8.46 cm 3.3 in
Height	2.42 cm .952 in	10.1 cm 4 in	2.3 cm 0.93 in.	2.54 cm 1 in	3.6 cm 1.4 in	4.06 cm 1.6 in		2.42 cm .952 in
Weight	189.9 g 6.1oz	64 g 2.25 oz	59.5 g 2.1 oz	1.39 kg 3.05 lbs	2.4 kg 5.3 lbs	3.2 kg 7.05 lbs		189.9g 6.1 oz
Ambient Temperature	0-60° C 32-122° F	0-60° C 32-140° F	10-45° C 50-113° F	0-55° C 32-131° F				-35-75° C -31-167° F
Relative humidity	5%-90% non-condensing							
Altitude	0 to 12,000 feet 0 to 3,658 meters							

Digi One IA DB9 and Screw Terminal Pinouts

DB9 Pin	EIA-232	EIA-422/485 Full-Duplex	EIA-485 Half-Duplex	Screw Terminal
1	DCD	CTS-	Not used	9
2	RxD	RxD+	RxD+	6
3	TxD	TxD+	TxD+	3
4	DTR	RTS-	Not used	2
5	GND	GND	GND	5
6	DSR	RxD-	RxD-	7
7	RTS	RTS+	Not used	1
8	CTS	CTS+	Not used	8
9	NA	TxD-	TxD-	4

PortServer TS 1 M MEI and PortServer TS 3 M MEI

- ITU-T V.92/V.90/56K (-92 build option)
- V.34/V.33.6 (-34 build option)
- V.32 bis/14.4K (-32 build option)
- V.22 bis/2400 baud (-22 build option)
- V.22
- V.23
- V.21
- Bell 212A and Bell 103
- V.44 Error Correction
- V.42 LAPM, MNP 2-4 Error Correction
- V.42 bis and MNP Class 5 data compression

FCC Class A Statement

Applicable to these products:

- Digi One SP
- Digi One IA
- Digi One IAP
- Digi One PortServer TS 8
- PortServer TS 8 MEI
- PortServer TS 16 MEI
- PortServer TS 16 Rack DC

These devices comply with part 15 of the FCC rules. Operation is subject to the following two conditions: (1) These devices may not cause harmful interference, and (2) These devices must accept any interference received, including interference that may cause harmful operation.

Regulatory Notices

Product	FCC P15 Subpart B, Class B	FCC P15 Subpart B, Class A	ICES-003, Class B	ICES-003, Class A	EN 55022 Class B	EN 55022 Class A	AS/NZS 3548	VCCI	EN 61000-3-2	EN 61000-3-3	EN 61000-6-2	EN 301 489-3	EN 55024	UL 60950-1/ CSA C22.2 No.60950-1	UL 60950/ CSA C22.2 No.60950	UL 1604 Class 1 Div 2	IEC 60950/ EN 60950	IEC 60950-1/ EN 60950-1
PortServer TS 1	X	-	X	-	X	-	X	X	X	X	-	-	X	-	X	-	X	-
PortServer TS 2	X	-	X	-	X	-	X	X	X	X	-	-	X	-	X	-	X	-
PortServer TS 4	X	-	X	-	X	-	X	X	X	X	-	-	X	-	X	-	X	-
PortServer TS 1 MEI	X	-	X	-	X	-	X	X	X	X	-	-	X	-	X	-	X	-
PortServer TS 2 MEI	X	-	X	-	X	-	X	X	X	X	-	-	X	-	X	-	X	-
PortServer TS 4 MEI	X	-	X	-	X	-	X	X	X	X	-	-	X	-	X	-	X	-
PortServer TS 1 M MEI	X	-	X	-	X	-	X	X	-	-	-	-	-	X	-	-	-	-
PortServer TS 3 M MEI	X	-	X	-	X	-	X	X	-	-	-	-	-	X	-	-	-	-
PortServer TS 1 W MEI	X	-	X	-	X	-	X	X	X	X	-	X	X	-	X	-	X	-
PortServer TS 2 W MEI	X	-	X	-	X	-	X	X	X	X	-	X	X	-	X	-	X	-
PortServer TS 4 W MEI	X	-	X	-	X	-	X	X	X	X	-	X	X	-	X	-	X	-
PortServer TS 1 P MEI	X	-	X	-	X	-	X	X	X	X	-	-	X	-	X	-	X	-
PortServer TS 2 P MEI	X	-	X	-	X	-	X	X	X	X	-	-	X	-	X	-	X	-
PortServer TS 4 P MEI	X	-	X	-	X	-	X	X	X	X	-	-	X	-	X	-	X	-
PortServer TS 1 H ^{CC} MEI	X	-	X	-	X	-	X	X	X	X	-	-	X	-	X	-	X	-
PortServer TS 2 H ^{CC} MEI	X	-	X	-	X	-	X	X	X	X	-	-	X	-	X	-	X	-
PortServer TS 4 H ^{CC} MEI	X	-	X	-	X	-	X	X	X	X	-	-	X	-	X	-	X	-
PortServer TS 1 H MEI	X	-	X	-	X	-	X	X	X	X	-	-	X	-	X	-	X	-
PortServer TS 2 H MEI	X	-	X	-	X	-	X	X	X	X	-	-	X	-	X	-	X	-
PortServer TS 4 H MEI	X	-	X	-	X	-	X	X	X	X	-	-	X	-	X	-	X	-
PortServer TS 1 Haz MEI	X		X		X		X	X	X	X			X		X	X	X	
PortServer TS 2 Haz MEI	X		X		X		X	X	X	X			X		X	X	X	
PortServer TS 4 Haz MEI	X		X		X		X	X	X	X			X		X	X	X	
PortServer TS 16	X	-	X	-	X	-	X	X	X	X	-	-	X	-	X	-	X	-
PortServer TS 8	-	X	-	X	-	X	X	X	X	X	-	-	X	-	X	-	X	-
PortServer TS 8 MEI	-	X	-	X	-	X	X	X	X	X	-	-	X	X	-	-	-	X
PortServer TS 16 MEI	-	X	-	X	-	X	X	X	X	X	-	-	X	X	-	-	-	X
PortServer TS 16 Rack DC	-	X	-	X	-	X	X	X	X	X	-	-	X	X	-	-	-	X
Digi One IA	-	X	-	X	-	X	X	X	-	-	X	-	X	-	X	X	X	-
Digi One SP	-	X	-	X	-	X	X	X	X	X	-	-	X	-	X	-	X	-
Digi One IAP	-	X	-	X	-	X	X	X	-	-	X	-	X	-	X	-	X	-
Digi One IAP Haz																		
PortServer TS 16 Enterprise	X	-	X	-	X	-	X	X	X	X	-	-	X	-	X	-	X	X

Certifications

FCC Part 15 Class A

Applicable to these products:

- Digi One IA
- Digi One IAP
- Digi One IAP Haz
- Digi One SP
- PortServer TS 8
- PortServer TS 8 MEI
- PortServer TS 16 MEI

These devices comply with part 15 of the FCC rules. Operation is subject to the following two conditions: (1) These devices may not cause harmful interference, and (2) These devices must accept any interference received, including interference that may cause harmful operation.

Radio Frequency Interference (RFI) (FCC 15.105)

This equipment has been tested and found to comply with the limits for Class A digital devices pursuant to Part 15 of the FCC Rules. These limits are designed to provide reasonable protection against harmful interference in a residential environment. This equipment generates, uses, and can radiate radio frequency energy, and if not installed and used in accordance with the instruction manual, may cause harmful interference to radio communications. However, there is no guarantee that interference will not occur in a particular installation. If this equipment does cause harmful interference to radio or television reception, which can be determined by turning the equipment off and on, the user is encouraged to try and correct the interference by one or more of the following measures:

- Reorient or relocate the receiving antenna.
- Increase the separation between the equipment and the receiver.
- Connect the equipment into an outlet on a circuit different from that to which the receiver is connected.
- Consult the dealer or an experienced radio/TV technician for help.

Labeling Requirements (FCC 15.19)

This device complies with Part 15 of FCC rules. Operation is subject to the following two conditions: (1) this device may not cause harmful interference, and (2) this device must accept any interference received, including interference that may cause undesired operation.

Modifications (FCC 15.21)

Changes or modifications to this equipment not expressly approved by Digi may void the user's authority to operate this equipment.

Cables (FCC 15.27)

Shielded cables *must* be used to remain within the Class A limitations.

ICES 003 Class B

Applicable to these products:

- Digi One TS
- Digi One TS Wireless
- PortServer TS 2/4 MEI
- PortServer TS 2/4 Wireless
- PortServer TS 16

This digital apparatus does not exceed the Class B limits for radio noise emissions from digital apparatus set out in the Radio Interference Regulations of the Canadian Department of Communications.

Le présent appareil numérique n'émet pas de bruits radioélectriques dépassant les limites applicables aux appareils numériques de la class B prescrites dans le Règlement sur le brouillage radioélectrique édicté par le ministère des Communications du Canada.

Antennae (Wireless only)

Digi Wireless products can only use the Digi antennae provided in the box.

Maximum Permissible Exposure (Wireless only)

To comply with Maximum Permissible Exposure requirements, antennas must be installed to provide at least 20 cm of separation from all persons per FCC 47 CFR 2.1091.

Certifications

Declaration of Conformity

(in accordance with FCC Dockets 96-208 and 95-19)

Digi International declares, that the product:

Manufacturer's Name:	Corporate Headquarters:	Manufacturing Headquarters:
Digi International	11001 Bren Road East Minnetonka MN 55343	10000 West 76th Street Eden Prairie MN 55344

Product Name	Model Number
PortServer TS 1	50000836-13
PortServer TS 2	50000836-14
PortServer TS 4	50000836-15
PortServer TS 1 MEI	50000836-25
PortServer TS 2 MEI	50000836-26
PortServer TS 4 MEI	50000836-27
PortServer TS 1 M MEI	50000836-28
PortServer TS 3 M MEI	50000836-29
PortServer TS 1 W MEI	50000836-30
PortServer TS 2 W MEI	50000836-31
PortServer TS 4 W MEI	50000836-32
PortServer TS 1 P MEI	50000836-47
PortServer TS 2 P MEI	50000836-48
PortServer TS 4 P MEI	50000836-49
PortServer TS 1 H MEI	50000836-41
PortServer TS 2 H MEI	50000836-42
PortServer TS 4 H MEI	50000836-43
PortServer TS 1 H ^{CC} MEI	50000836-38
PortServer TS 2 H ^{CC} MEI	50000836-39
PortServer TS 4 H ^{CC} MEI	50000836-40
PortServer TS 1 Haz MEI	50000836-51
PortServer TS 2 Haz MEI	50000836-52
PortServer TS 4 Haz MEI	50000836-53
PortServer TS 16	50001207-01
PortServer TS 16 Rack	50000854-01
PortServer TS 16 DC Rack	50000722-01
PortServer TS 16 Enterprise	50000855-01

to which this declaration relates, meets the requirements specified by the Federal Communications Commission as detailed in the following specifications:

- Part 15, Subpart B, for Class B Equipment
- FCC Docket 96-208 as it applies to Class B personal
- Computers and Peripherals

The products listed above have been tested at an External Test Laboratory certified per FCC rules and have been found to meet the FCC, Part 15, Class B, Emission Limits. Documentation is on file and available from the Digi International Homologation Department.

